

## **LINEAR LIGHT**

# A10-1001

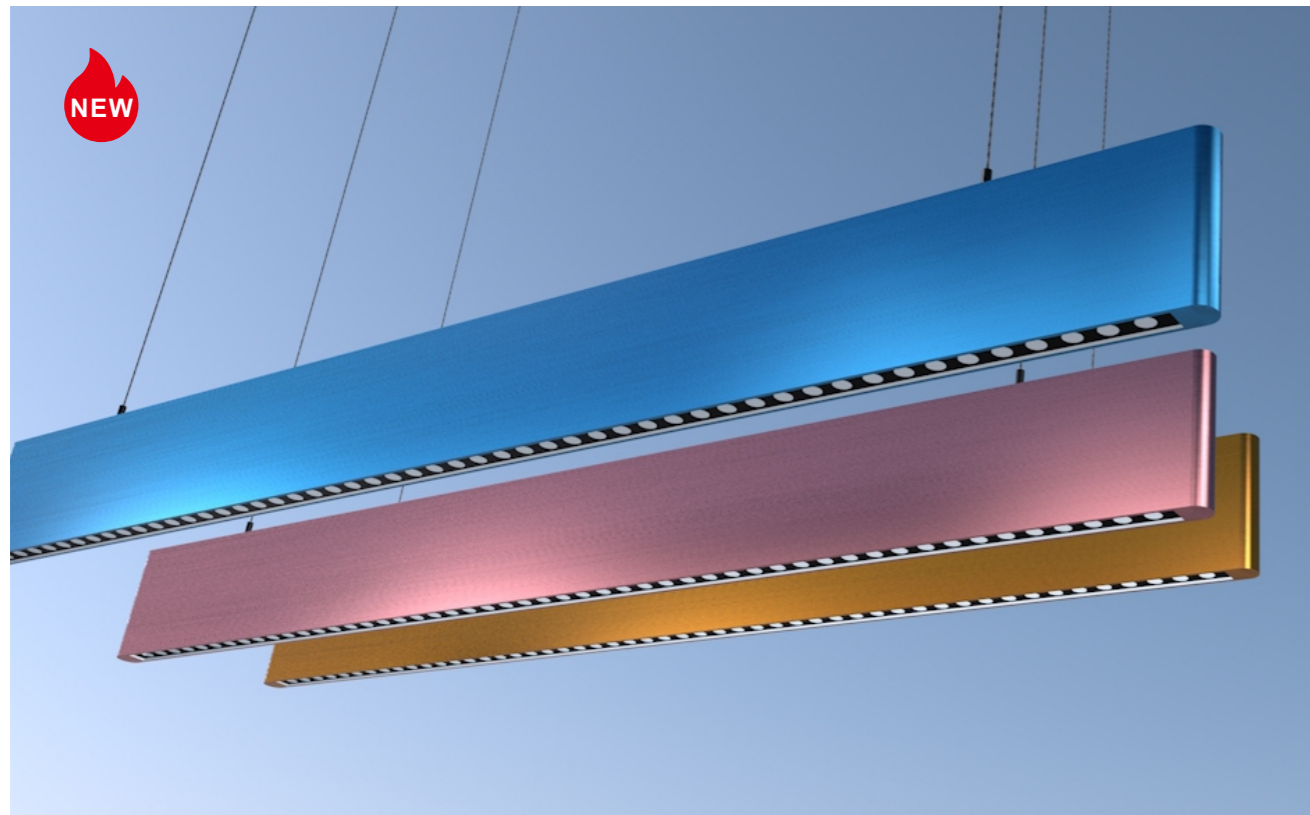

## PRODUCT FEATURES

1. The rich color appearance, combined with the high-quality oxidized brushed aluminum profile lamp body, liven up your interior spaces with passion.
2. Not only meet your lighting needs, but also the shape of the bendable lamp body can meet the decoration needs of interior design.
3. Lens and Diffuser is available

## APPLICATIONS

Suitable for office lighting fields and commercial lighting fields

## STANDARD SURFACE COLOR



## DIMENSION

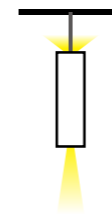
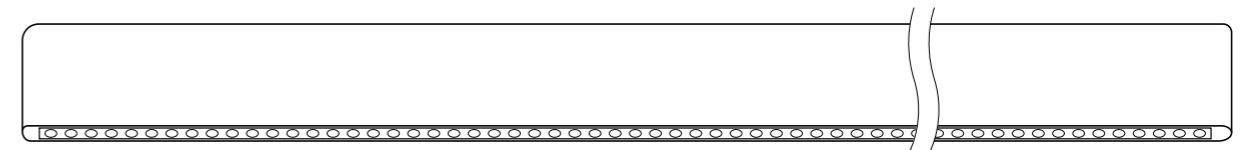

3000K 4000K 6000K

## PRODUCT SPECIFICATION

Voltage	DC36V
Power	UP 15W+ DOWN 30W
Factor	0.95
Light Source Flux	UP 100lm/w+ DOWN 105lm/w
System Flux	UP 1500lm/w+ DOWN 3150lm/w
CRI	RA≥93
SDCM	≤3 STEPS
UGR	<10
Beam Angle	UP 100° DOWN 36°
Dimming	1-10V DALI OPTIONAL
IP/IK	IP20
Protection	CLASS III
Rated Lifespan	50,000 HOURS

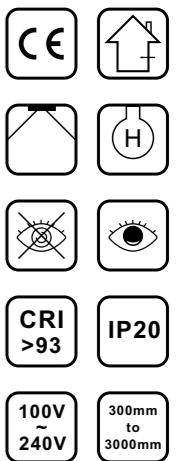

# A10-1002

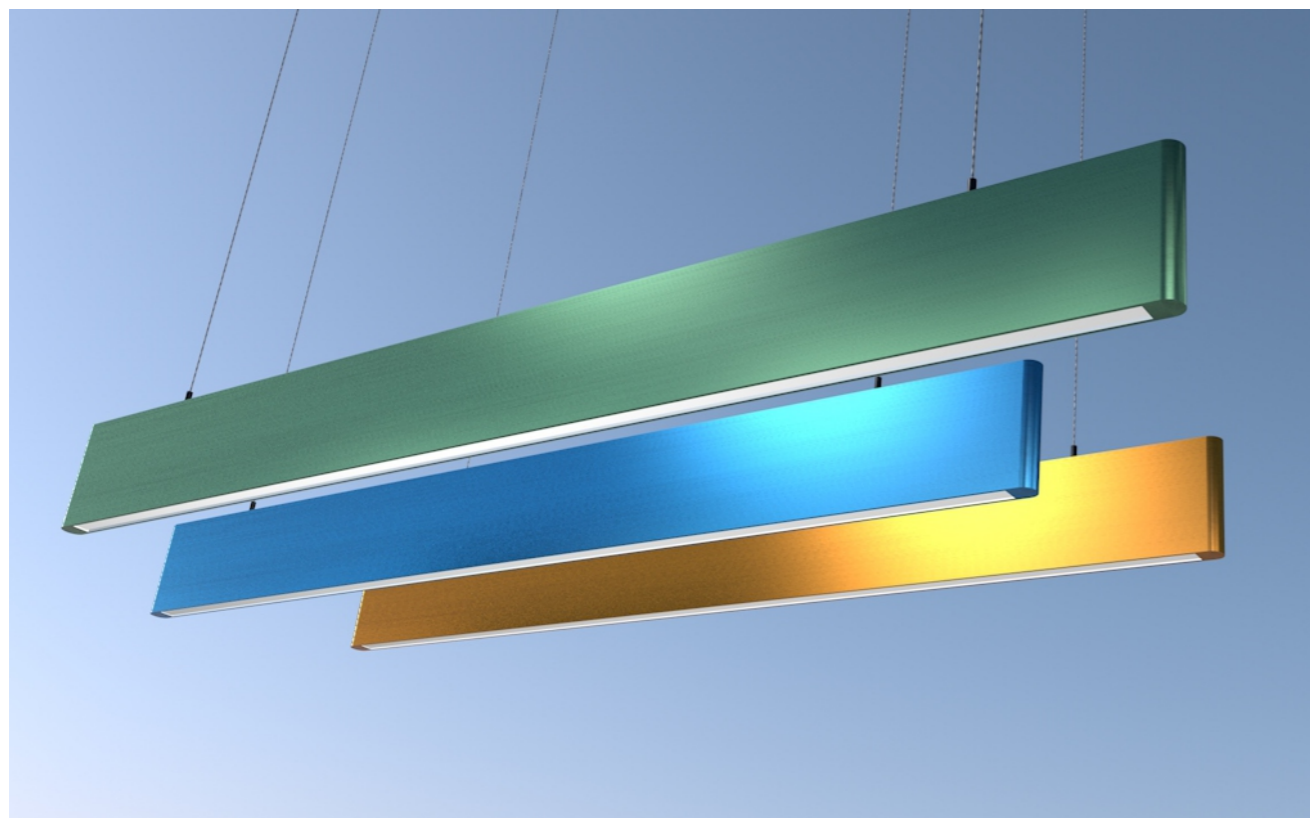

## PRODUCT FEATURES

- 1.The rich color appearance, combined with the high-quality oxidized brushed aluminum profile lamp body, liven up your interior spaces with passion.
2. Not only meet your lighting needs, but also the shape of the bendable lamp body can meet the decoration needs of interior design.
- 3.Lens and Diffuser is available

## APPLICATIONS

Suitable for office lighting fields and commercial lighting fields

## STANDARD SURFACE COLOR



## DIMENSION

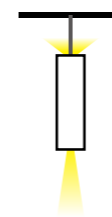
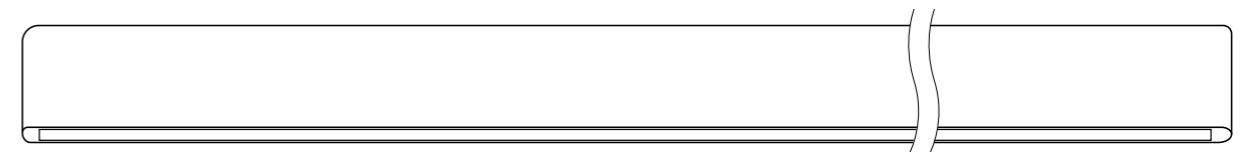

3000K 4000K 6000K

## PRODUCT SPECIFICATION

Voltage	DC36V
Power	UP 15W+ DOWN 30W
Factor	0.95
Light Source Flux	UP 100lm/w+ DOWN 80lm/w
System Flux	UP 1500lm/w+ DOWN 2400lm/w
CRI	RA≥93
SDCM	≤3 STEPS
UGR	<10
Beam Angle	UP 100° DOWN 80°
Dimming	1-10V DALI OPTIONAL
IP/IK	IP20
Protection	CLASS III
Rated Lifespan	50,000 HOURS

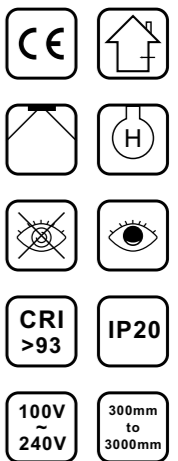

# A10-1003

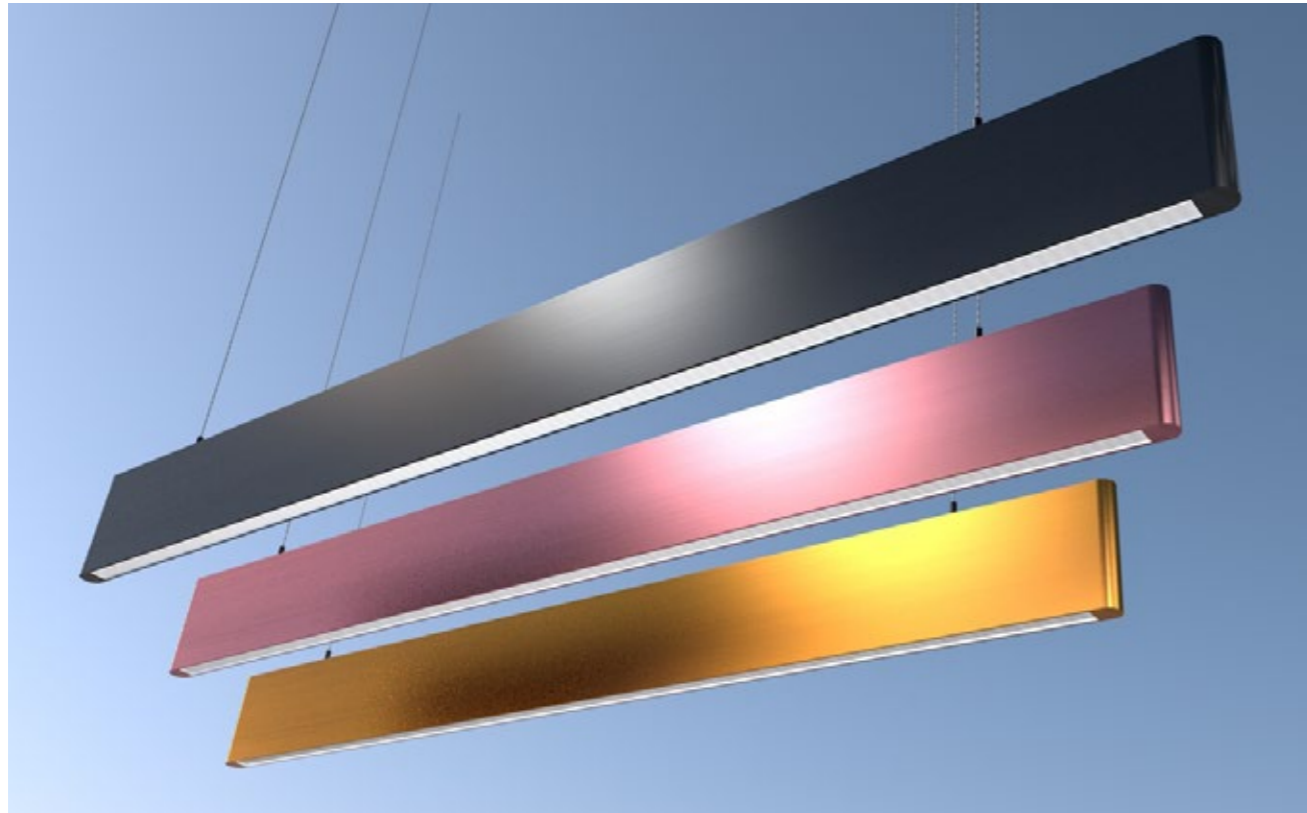

## PRODUCT FEATURES

- 1.The rich color appearance, combined with the high-quality oxidized brushed aluminum profile lamp body, liven up your interior spaces with passion.
2. Not only meet your lighting needs, but also the shape of the bendable lamp body can meet the decoration needs of interior design.
- 3.Lens and Diffuser is available

## APPLICATIONS

Suitable for office lighting fields and commercial lighting fields

## STANDARD SURFACE COLOR



## DIMENSION

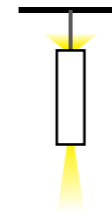
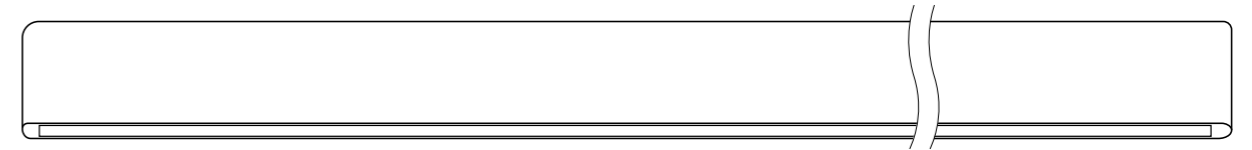

3000K 4000K 6000K

## PRODUCT SPECIFICATION

Voltage	DC36V
Power	UP 15W+ DOWN 30W
Factor	0.95
Light Source Flux	UP 100lm/w+ DOWN 80lm/w
System Flux	UP 1500lm/w+ DOWN 2400lm/w
CRI	RA≥93
SDCM	≤3 STEPS
UGR	<10
Beam Angle	UP 100° DOWN 80°
Dimming	1-10V DALI OPTIONAL
IP/IK	IP20
Protection	CLASS III
Rated Lifespan	50,000 HOURS

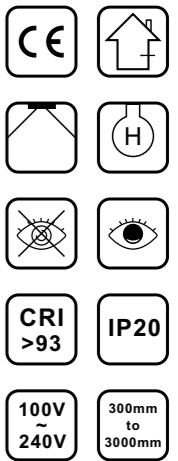

# B20-2008



## PRODUCT FEATURES

Efficient, Isolated, brand driver  
 TRIAC 1-10V 2.4G DALI DALI-DT8 Dimming  
 High bright SMD chip, Lumen: 130lm/w

## STANDARD SURFACE COLOR



## DIMENSION

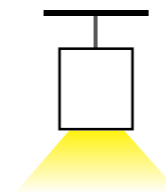
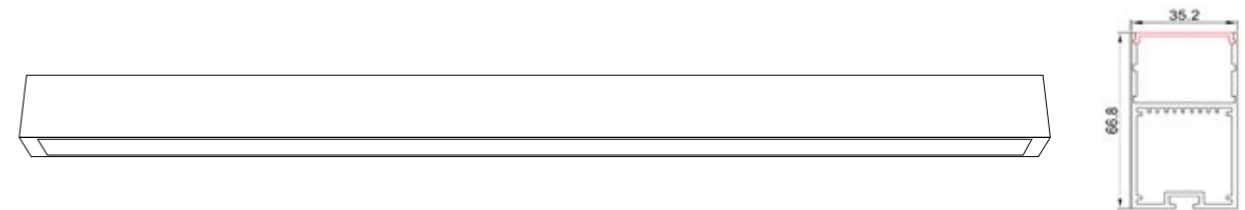

3000K 4000K 6500K

## PRODUCT SPECIFICATION

Voltage	DC36V
Factor	0.95
Light Source Flux	130lm/w
CRI	≥90
SDCM	≤3 STEPS
UGR	<10
Dimming	1-10V DALI OPTIONAL
IP/IK	IP20
Protection	CLASS III
Rated Lifespan	50,000 HOURS

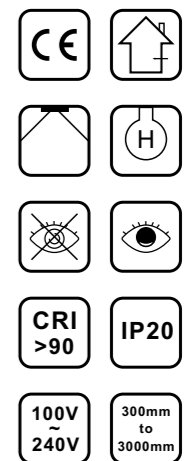

## PRODUCT PARAMETER

MODEL	LED OUPUT	POWER	SIZE(MM)
B20-2008	1950lm	15W	L606*W35*H67
B20-2008	3900lm	30W	L1206*W35*H67
B20-2008	5850lm	45W	L1806*W35*H67
B20-2008	7800lm	60W	L2406*W35*H67

**B20-2009**



**PRODUCT FEATURES**

Modular structure design, Reduce late maintenance costs  
 Efficient, Isolated, brand driver  
 TRIAC 1-10V 2.4G DALI DALI-DT8 Dimming  
 High bright SMD chip, Lumen: 130lm/w

**STANDARD SURFACE COLOR**



**DIMENSION**

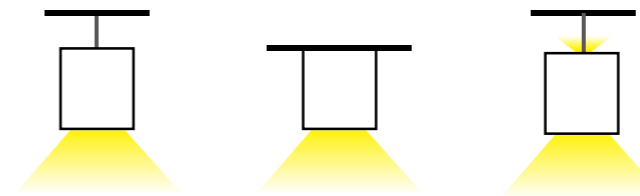
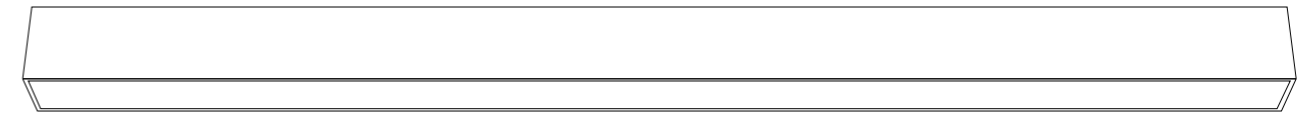

3000K 4000K 6500K

**PRODUCT SPECIFICATION**

Voltage	DC36V
Factor	0.95
Light Source Flux	130lm/w
CRI	≥90
SDCM	≤3 STEPS
UGR	<10
Dimming	1-10V DALI OPTIONAL
IP/IK	IP20
Protection	CLASS III
Rated Lifespan	50,000 HOURS

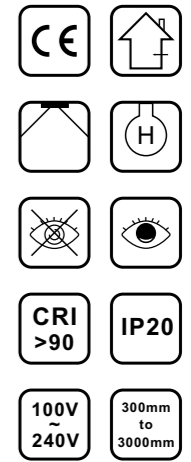

**PRODUCT PARAMETER**

MODEL	LED OUPUT	POWER	SIZE(MM)
B20-2009	1950lm	15W	L606*W50*H75
B20-2009	3900lm	30W	L1206*W50*H75
B20-2009	5850lm	45W	L1806*W50*H75
B20-2009	7800lm	60W	L2406*W50*H75
B20-2009	2860lm	22W	L606*W50*H90
B20-2009	5850lm	45W	L1206*W50*H90
B20-2009	8840lm	68W	L1806*W50*H90
B20-2009	11700lm	90W	L2406*W50*H90

# B20-2010

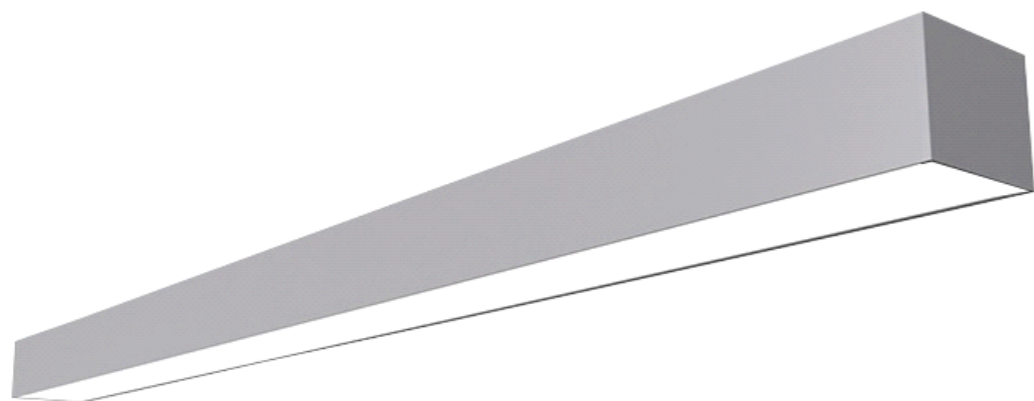

## PRODUCT FEATURES

Modular structure design, Reduce late maintenance costs  
 Efficient, Isolated, brand driver  
 TRIAC 1-10V 2.4G DALI DALI-DT8 Dimming  
 High bright SMD chip, Lumen: 130lm/w

## STANDARD SURFACE COLOR



## DIMENSION

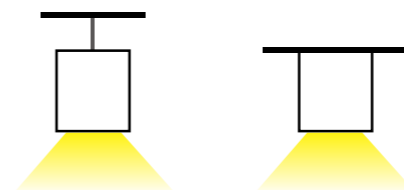
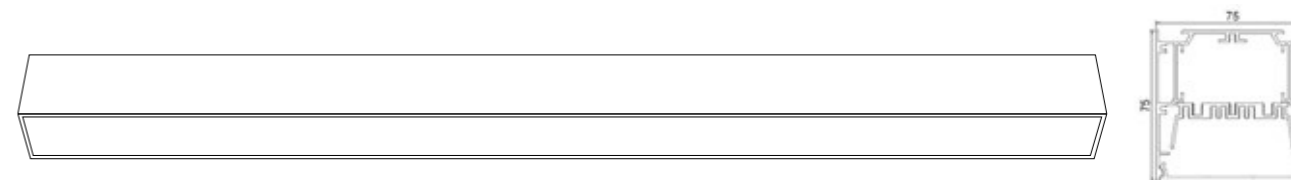

3000K 4000K 6500K

## PRODUCT SPECIFICATION

Voltage	DC36V
Factor	0.95
Light Source Flux	130lm/w
CRI	≥90
SDCM	≤3 STEPS
UGR	<10
Dimming	1-10V DALI OPTIONAL
IP/IK	IP20
Protection	CLASS III
Rated Lifespan	50,000 HOURS

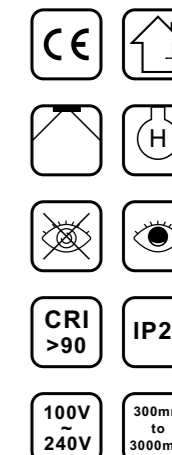

## PRODUCT PARAMETER

MODEL	LED OUPUT	POWER	SIZE(MM)
B20-2010	1950lm	15W	L606*W75*H75
B20-2010	3900lm	30W	L1206*W75*H75
B20-2010	5850lm	45W	L1806*W75*H75
B20-2010	7800lm	60W	L2406*W75*H75

B20-2011

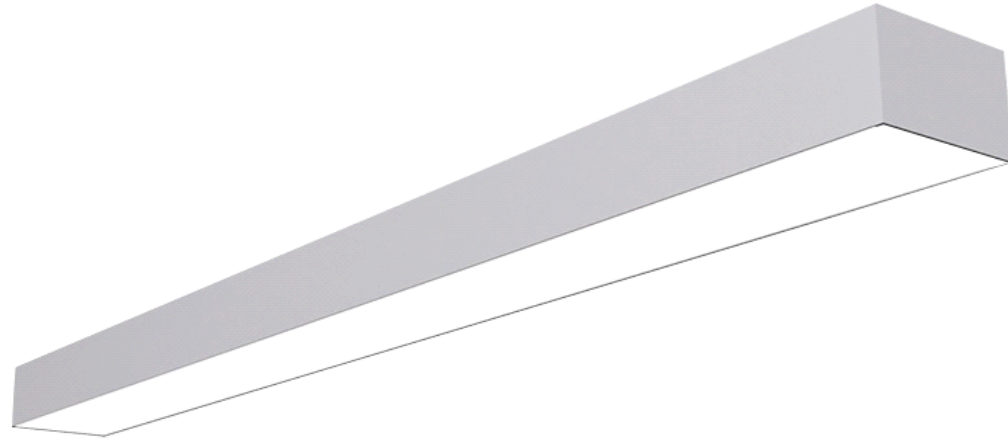

**PRODUCT FEATURES**

Modular structure design, Reduce late maintenance costs  
 Efficient, Isolated, brand driver  
 TRIAC 1-10V 2.4G DALI DALI-DT8 Dimming  
 High bright SMD chip, Lumen: 130lm/w

**STANDARD SURFACE COLOR**



**DIMENSION**

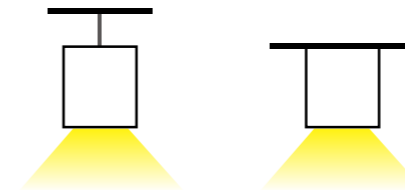
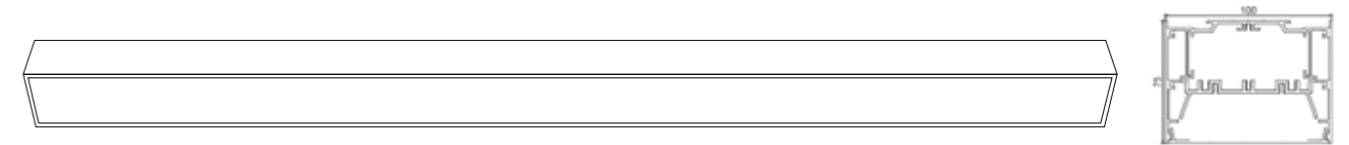

3000K 4000K 6500K

**PRODUCT SPECIFICATION**

Voltage	DC36V
Factor	0.95
Light Source Flux	130lm/w
CRI	≥90
SDCM	≤3 STEPS
UGR	<10
Dimming	1-10V DALI OPTIONAL
IP/IK	IP20
Protection	CLASS III
Rated Lifespan	50,000 HOURS

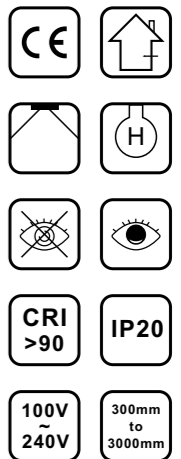

**PRODUCT PARAMETER**

MODEL	LED OUPUT	POWER	SIZE(MM)
B20-2011	1950lm	15W	L606*W100*H75
B20-2011	3900lm	30W	L1206*W100*H75
B20-2011	5850lm	45W	L1806*W100*H75
B20-2011	7800lm	60W	L2406*W100*H75

C30-3002

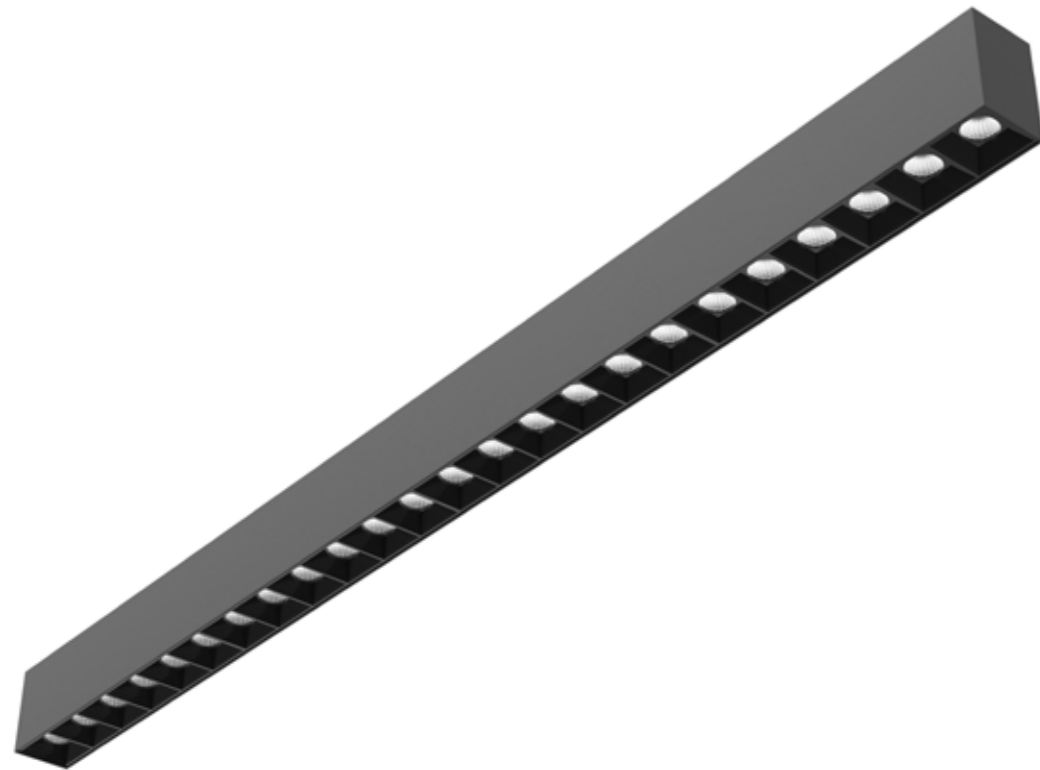

**PRODUCT FEATURES**

AL6063-T5 material, The latest lighting product designed by HILED, has optimized the internal structure of profiles, adapted the anti-glare design with luminous efficiency up to 130lm/w and brought new trend to light design for expansion module with spot light

**SURFACE PROCESSING**

Spraying RAL9003 White/Spraying RAL9005 Black

**STANDARD SURFACE COLOR**



**DIMENSION**

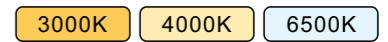
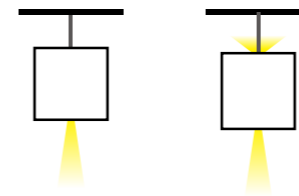
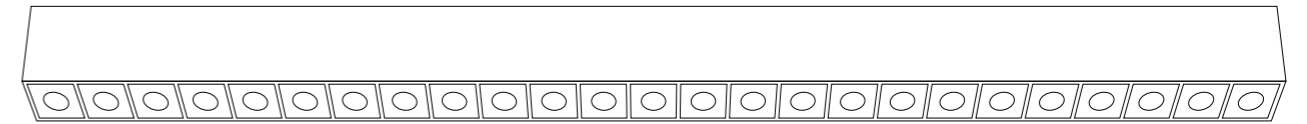

**PRODUCT SPECIFICATION**

Voltage	DC36V
Factor	0.95
Light Source Flux	130lm/w
CRI	≥90
SDCM	≤3 STEPS
UGR	<10
Beam Angle	15°,30°,45°
Dimming	1-10V DALI OPTIONAL
IP/IK	IP20
Protection	CLASS III
Rated Lifespan	50,000 HOURS

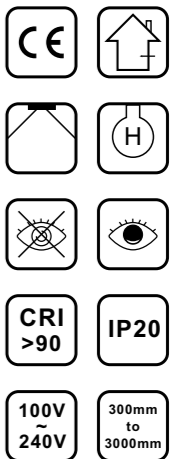

**PRODUCT PARAMETER**

MODEL	LED OUPUT	POWER	SIZE(MM)
C30-3002	3900lm	30W	L1145*W53*H80
C30-3002	5850lm	45W	L1145*W53*H90

C30-3003

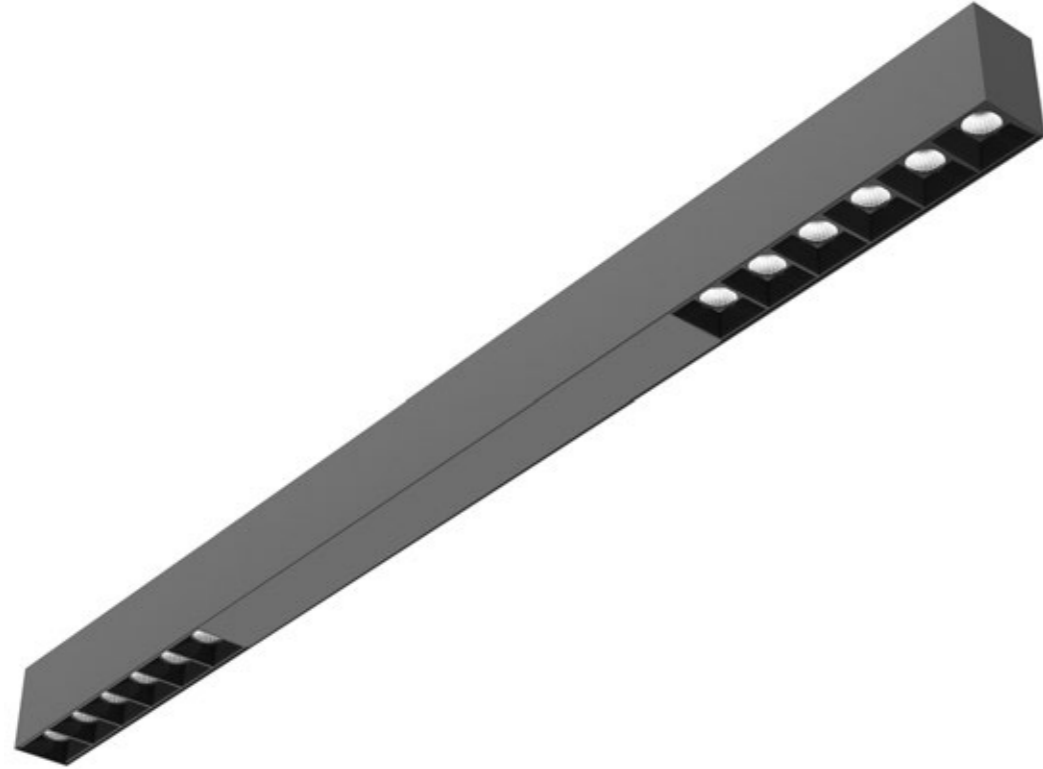

**PRODUCT FEATURES**

AL6063-T5 material, The latest lighting product designed by HILED, has optimized the internal structure of profiles, adapted the anti-glare design with luminous efficiency up to 130lm/w and brought new trend to light design for expansion module with spot light

**SURFACE PROCESSING**

Spraying RAL9003 White/Spraying RAL9005 Black

**STANDARD SURFACE COLOR**



**DIMENSION**

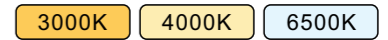
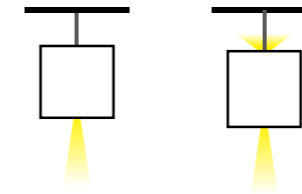
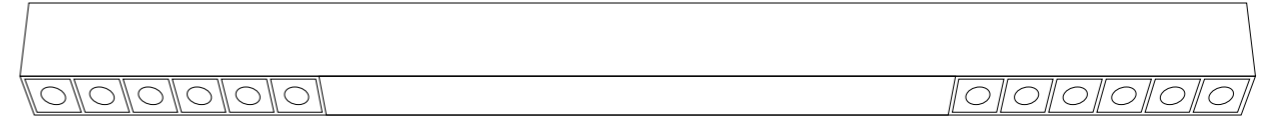

**PRODUCT SPECIFICATION**

Voltage	DC36V
Factor	0.95
Light Source Flux	130lm/w
CRI	≥90
SDCM	≤3 STEPS
UGR	<10
Beam Angle	15°, 30°, 45°
Dimming	1-10V DALI OPTIONAL
IP/IK	IP20
Protection	CLASS III
Rated Lifespan	50,000 HOURS

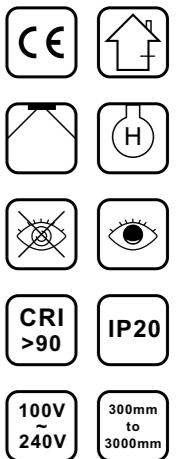

**PRODUCT PARAMETER**

MODEL	LED OUPUT	POWER	SIZE(MM)
C30-3003	3900lm	30W	L1145*W53*H80
C30-3003	5850lm	45W	L1145*W53*H90

# C30-3004

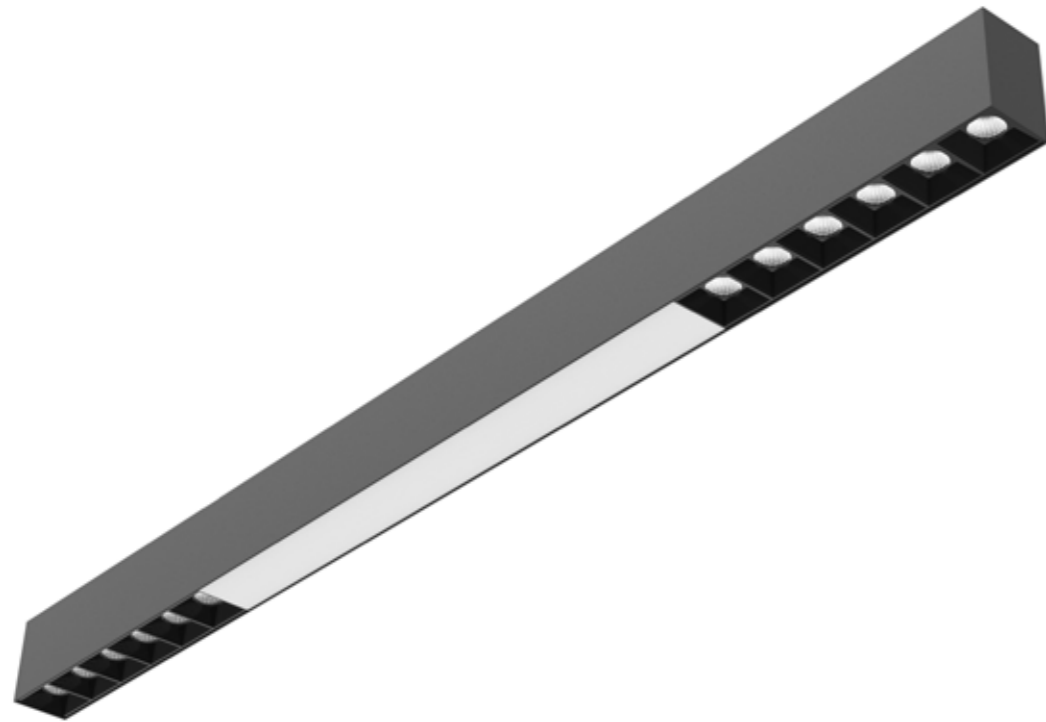

## PRODUCT FEATURES

AL6063-T5 material, The latest lighting product designed by HILED, has optimized the internal structure of profiles, adapted the anti-glare design with luminous efficiency up to 130lm/w and brought new trend to light design for expansion module with spot light

## SURFACE PROCESSING

Spraying RAL9003 White/Spraying RAL9005 Black

## STANDARD SURFACE COLOR



## DIMENSION

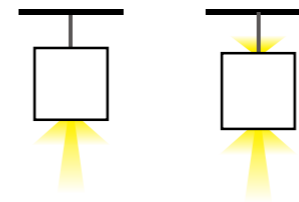
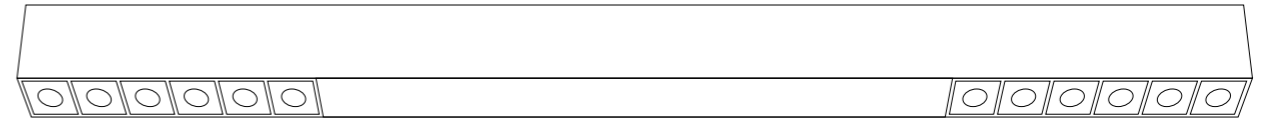

3000K 4000K 6500K

## PRODUCT SPECIFICATION

Voltage	DC36V
Factor	0.95
Light Source Flux	130lm/w
CRI	≥90
SDCM	≤3 STEPS
UGR	<10
Beam Angle	15°,30°,45°
Dimming	1-10V DALI OPTIONAL
IP/IK	IP20
Protection	CLASS III
Rated Lifespan	50,000 HOURS

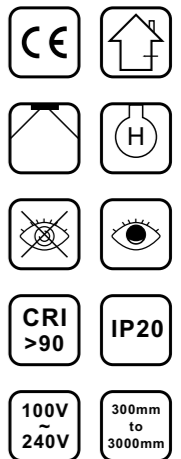

## PRODUCT PARAMETER

MODEL	LED OUPUT	POWER	SIZE(MM)
C30-3004	3900lm	30W	L1145*W53*H80
C30-3004	5850lm	45W	L1145*W53*H90

# C30-3005

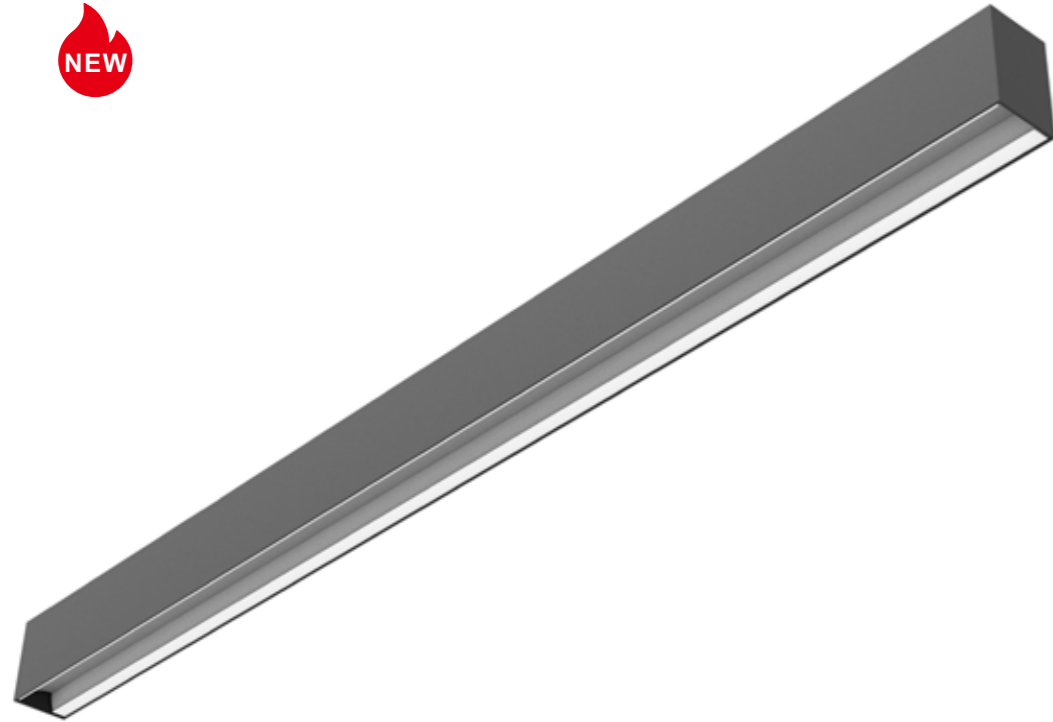

## PRODUCT FEATURES

AL6063-T5 material, The latest lighting product designed by HILED, has optimized the internal structure of profiles, adapted the anti-glare design with luminous efficiency up to 130lm/w and brought new trend to light design for expansion module with spot light

## SURFACE PROCESSING

Spraying RAL9003 White/Spraying RAL9005 Black

## STANDARD SURFACE COLOR



## DIMENSION

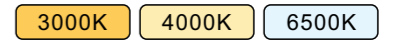
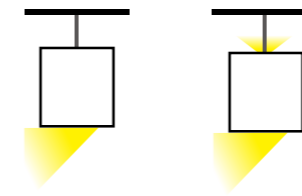
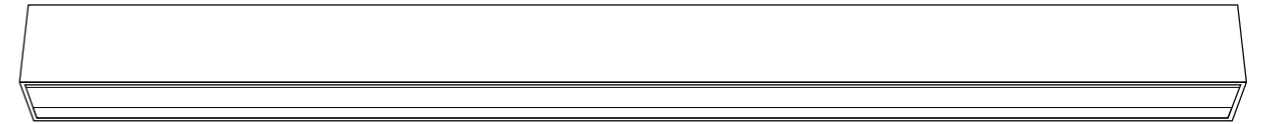

## PRODUCT SPECIFICATION

Voltage	DC36V
Factor	0.95
Light Source Flux	130lm/w
CRI	≥90
SDCM	≤3 STEPS
UGR	<10
Dimming	1-10V DALI OPTIONAL
IP/IK	IP20
Protection	CLASS III
Rated Lifespan	50,000 HOURS

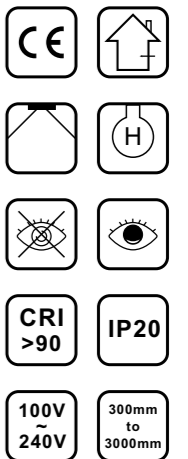

## PRODUCT PARAMETER

MODEL	LED OUPUT	POWER	SIZE(MM)
C30-3005	3380lm	26W	L1210*W53*H80
C30-3005	5850lm	45W	L1210*W53*H90

C30-3006

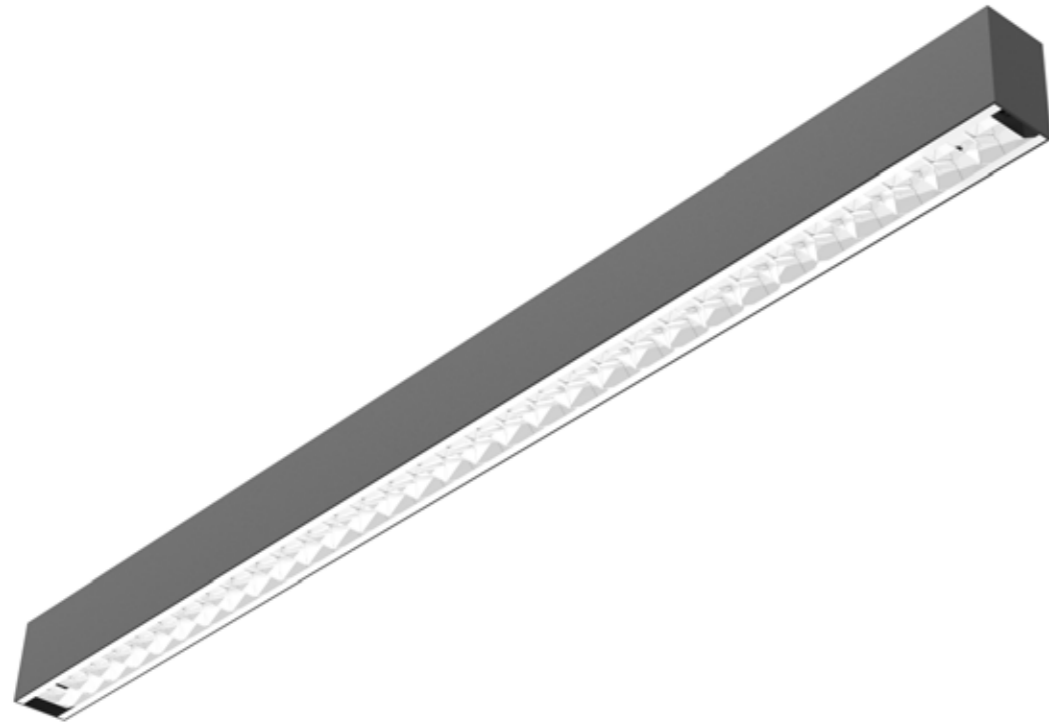

**PRODUCT FEATURES**

AL6063-T5 material, The latest lighting product designed by HILED, has optimized the internal structure of profiles, adapted the anti-glare design with luminous efficiency up to 130lm/w and brought new trend to light design for expansion module with spot light

**SURFACE PROCESSING**

Spraying RAL9003 White/Spraying RAL9005 Black

**STANDARD SURFACE COLOR**



**DIMENSION**

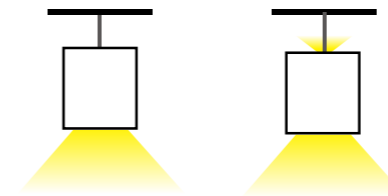
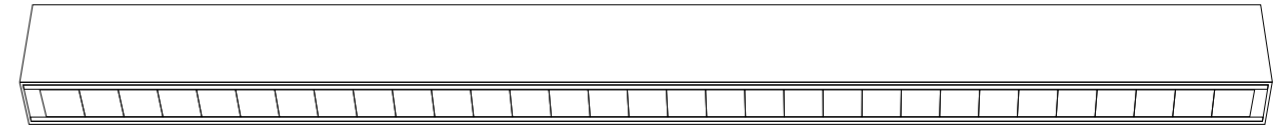

3000K 4000K 6500K

**PRODUCT SPECIFICATION**

Voltage	DC36V
Factor	0.95
Light Source Flux	130lm/w
CRI	≥90
SDCM	≤3 STEPS
UGR	< 10
Dimming	1-10V DALI OPTIONAL
IP/IK	IP20
Protection	CLASS III
Rated Lifespan	50,000 HOURS

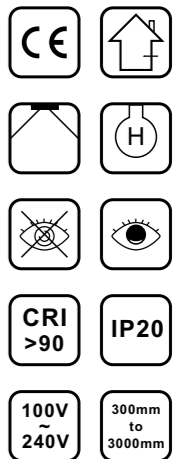

**PRODUCT PARAMETER**

MODEL	LED OUPUT	POWER	SIZE(MM)
C30-3006	3900lm	30W	L1145*W53*H80
C30-3006	5850lm	45W	L1145*W53*H90

# D40-4017

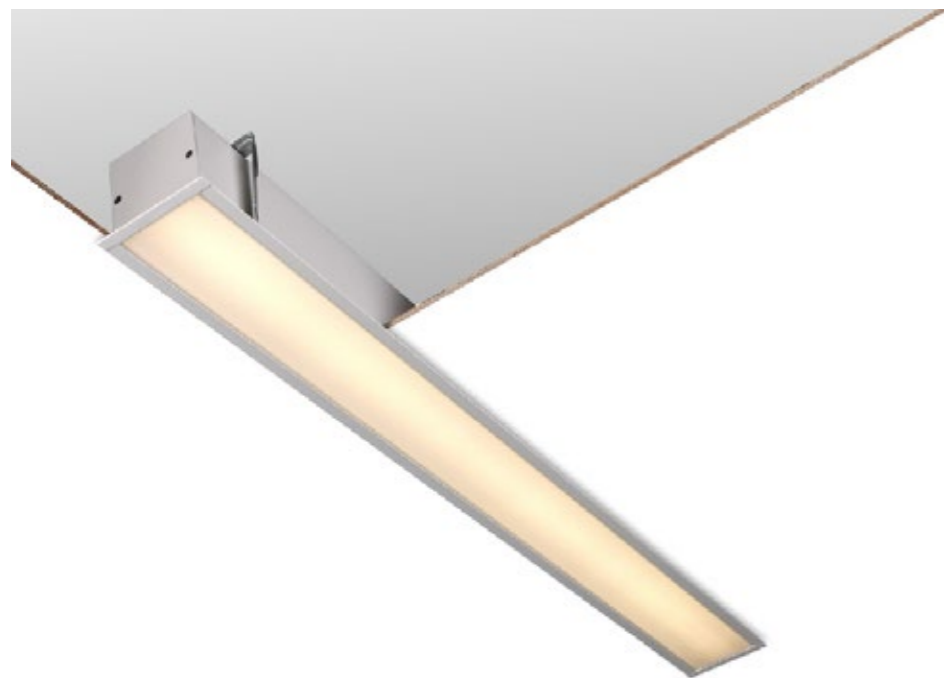

## PRODUCT FEATURES

Modular structure design, Reduce late maintenance costs  
 Efficient, Isolated, brand driver  
 TRIAC 0-10V DALI DALI-DT8 Dimming  
 High bright SMD chip, Lumen: 130lm/w

## STANDARD SURFACE COLOR



## DIMENSION

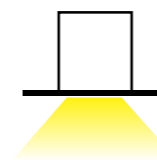
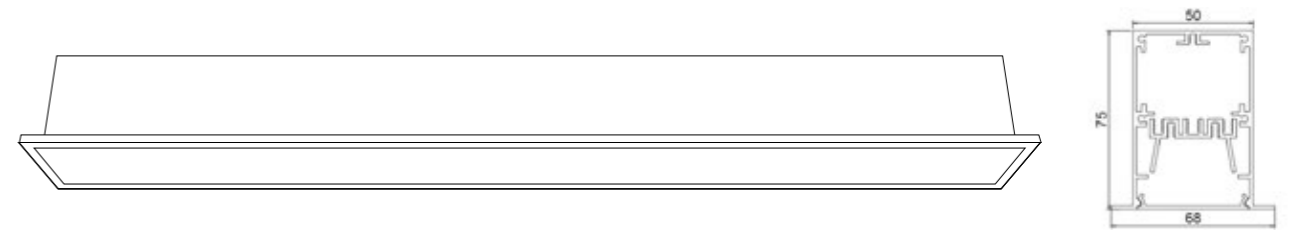

3000K 4000K 6500K

## PRODUCT SPECIFICATION

Voltage	DC36V
Factor	0.95
Light Source Flux	130lm/w
CRI	≥90
SDCM	≤3 STEPS
UGR	< 10
Dimming	0-10V DALI OPTIONAL
IP/IK	IP20
Protection	CLASS III
Rated Lifespan	50,000 HOURS

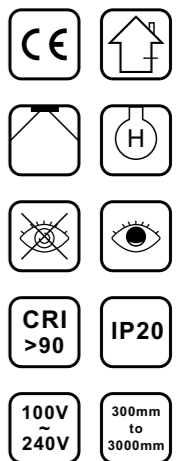

## PRODUCT PARAMETER

MODEL	LED OUPUT	POWER	SIZE(MM)
D40-4017	1950lm	15W	L606*W50*H75
D40-4017	3900lm	30W	L1204*W50*H75
D40-4017	5850lm	45W	L1803*W50*H75
D40-4017	7800lm	60W	L2404*W50*H75

# D40-4018

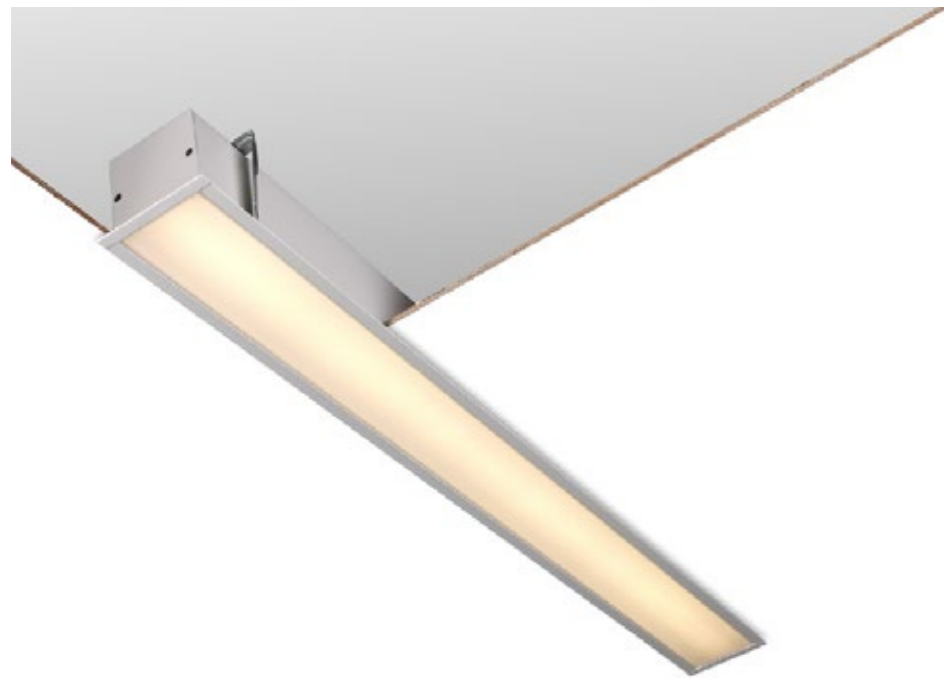

## PRODUCT FEATURES

Modular structure design, Reduce late maintenance costs  
 Efficient, Isolated, brand driver  
 TRIAC 0-10V DALI DALI-DT8 Dimming  
 High bright SMD chip, Lumen: 130lm/w

## STANDARD SURFACE COLOR



## DIMENSION

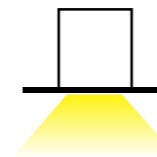
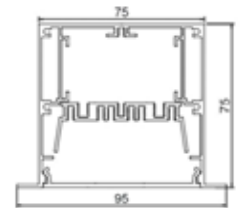
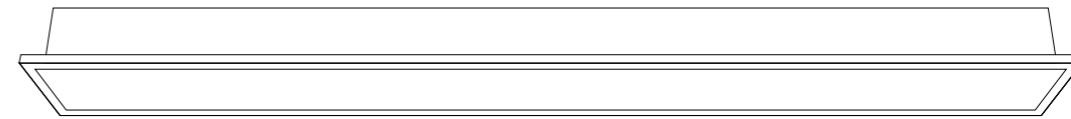

3000K 4000K 6500K

## PRODUCT SPECIFICATION

Voltage	DC36V
Factor	0.95
Light Source Flux	130lm/w
CRI	≥90
SDCM	≤3 STEPS
UGR	< 10
Dimming	0-10V DALI OPTIONAL
IP/IK	IP20
Protection	CLASS III
Rated Lifespan	50,000 HOURS

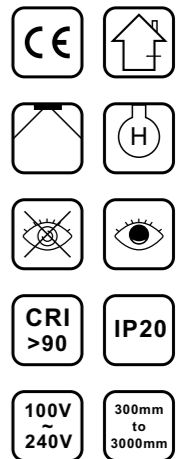

## PRODUCT PARAMETER

MODEL	LED OUPUT	POWER	SIZE(MM)
D40-4018	1950lm	15W	L606*W75*H75
D40-4018	3900lm	30W	L1204*W75*H75
D40-4018	5850lm	45W	L1803*W75*H75
D40-4018	7800lm	60W	L2404*W75*H75

# D40-4019

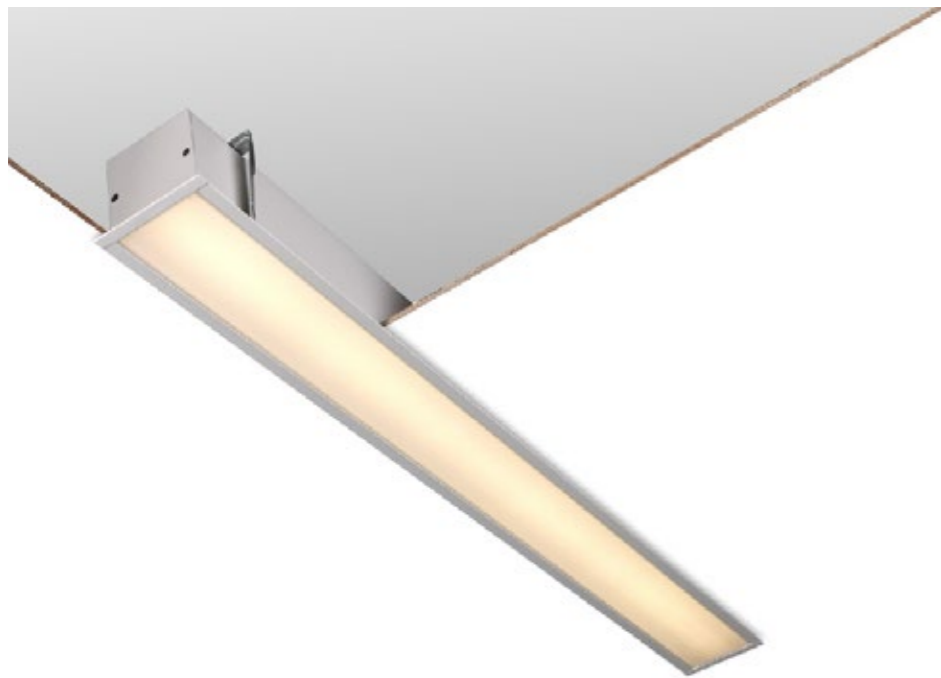

## PRODUCT FEATURES

Modular structure design, Reduce late maintenance costs  
 Efficient, Isolated, brand driver  
 TRIAC 0-10V DALI DALI-DT8 Dimming  
 High bright SMD chip, Lumen: 130lm/w

## STANDARD SURFACE COLOR



## DIMENSION

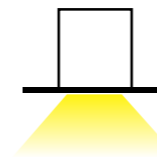
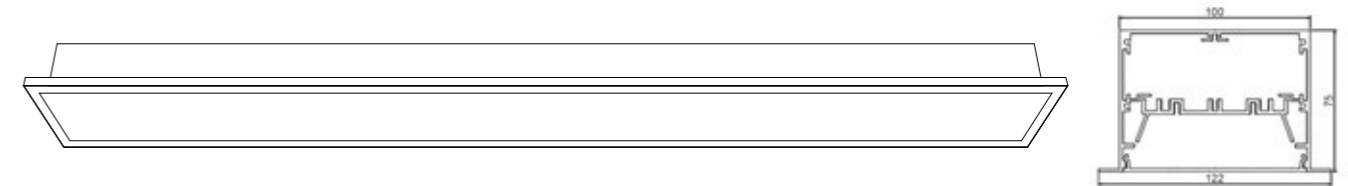

3000K 4000K 6500K

## PRODUCT SPECIFICATION

Voltage	DC36V
Factor	0.95
Light Source Flux	130lm/w
CRI	≥90
SDCM	≤3 STEPS
UGR	< 10
Dimming	0-10V DALI OPTIONAL
IP/IK	IP20
Protection	CLASS III
Rated Lifespan	50,000 HOURS

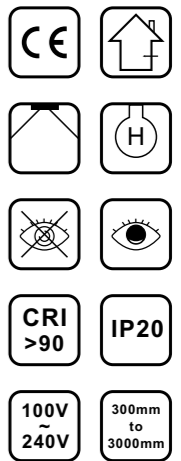

## PRODUCT PARAMETER

MODEL	LED OUPUT	POWER	SIZE(MM)
D40-4019	1950lm	15W	L606*W100*H75
D40-4019	3900lm	30W	L1204*W100*H75
D40-4019	5850lm	45W	L1803*W100*H75
D40-4019	7800lm	60W	L2404*W100*H75

# E50-5020



## PRODUCT FEATURES

T-Series 3/4 Wires Track linear light with concise design adopts 6063 aluminum, easy to installed, simple convenient and compatible with euro tracks

High bright SMD chip, Lumen : 130lm/w

## STANDARD SURFACE COLOR



## DIMENSION

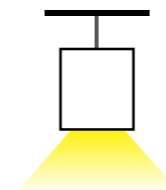
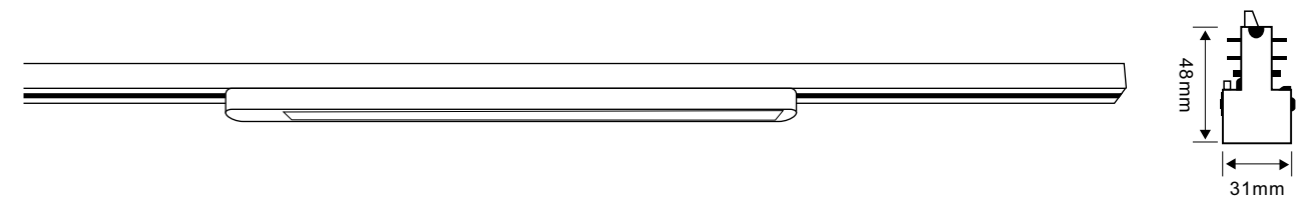

3000K 4000K 6500K

## PRODUCT SPECIFICATION

Voltage	DC36V
Factor	0.95
Light Source Flux	130lm/w
CRI	≥90
SDCM	≤3 STEPS
UGR	<10
Dimming	1-10V DALI OPTIONAL
IP/IK	IP20
Protection	CLASS III
Rated Lifespan	50,000 HOURS

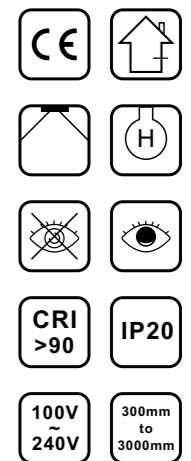

## PRODUCT PARAMETER

MODEL	LED OUPUT	POWER	SIZE(MM)
E50-5020	1950lm	15W	L680*W31*H48
E50-5020	3900lm	30W	L1280*W31*H48

# E50-5021



## PRODUCT FEATURES

TS-Series 3/4 Wires Track linear light with concise design adopts 6063 aluminum ,Rotatable horizontal 355°, east to installed simple convenient and compatible with euro tracks.  
High-light efficiency 120lm/w Various beam angle 90° & 60°for option with uniform light distribution.

## STANDARD SURFACE COLOR



## DIMENSION

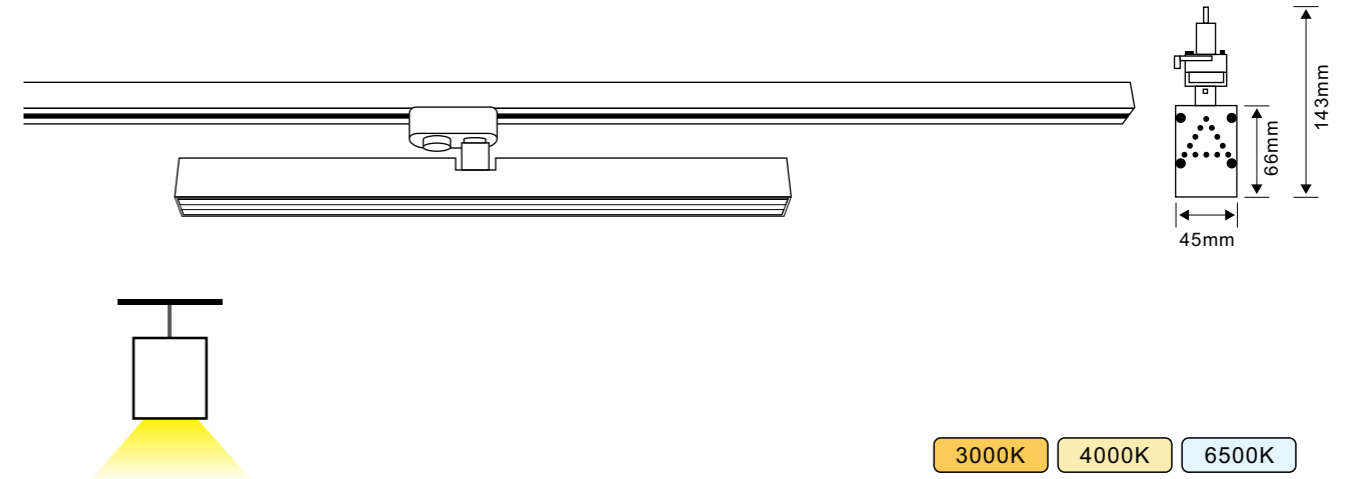

## PRODUCT SPECIFICATION

Voltage	DC36V
Factor	0.95
Light Source Flux	130lm/w
CRI	≥90
SDCM	≤3 STEPS
UGR	<10
Dimming	1-10V DALI OPTIONAL
IP/IK	IP20
Protection	CLASS III
Rated Lifespan	50,000 HOURS

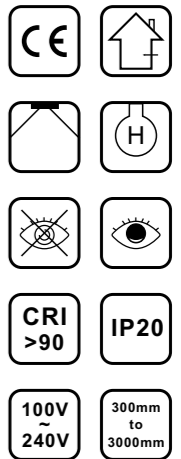

## PRODUCT PARAMETER

MODEL	LED OUPUT	POWER	SIZE(MM)
E50-5021	1950lm	30W	L571*W45*H143
E50-5021	3900lm	40W	L571*W45*H143

# E50-5022



## PRODUCT FEATURES

Twin tube 120° adjustable angle Trunking light is a linear track lights with UGR<19 louver reflector design ,easy to install with track rail High bright SMD chip,Lumen:130lm/w

## STANDARD SURFACE COLOR



## DIMENSION

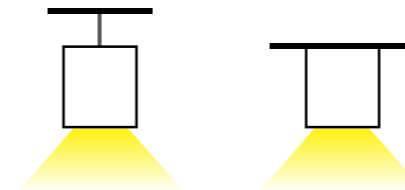
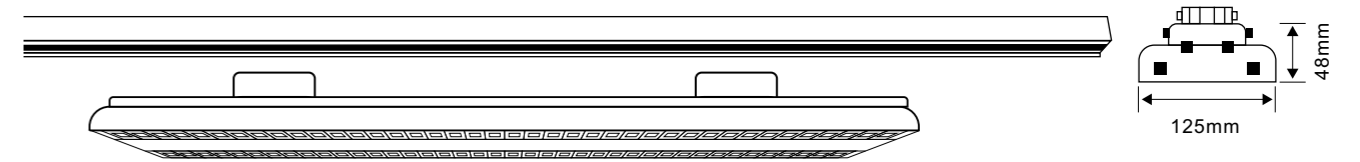

3000K 4000K 6500K

## PRODUCT SPECIFICATION

Voltage	DC36V
Factor	0.95
Light Source Flux	130lm/w
CRI	≥90
SDCM	≤3 STEPS
UGR	<10
Dimming	1-10V DALI OPTIONAL
IP/IK	IP20
Protection	CLASS III
Rated Lifespan	50,000 HOURS

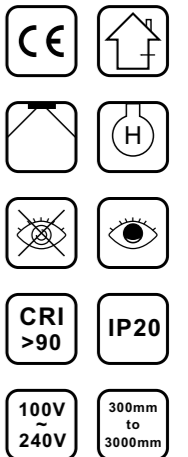

## PRODUCT PARAMETER

MODEL	LED OUPUT	POWER	SIZE(MM)
E50-5022	6000lm	40W	L1095*W125*H120
E50-5022	7500lm	50W	L1095*W125*H120
E50-5022	9000lm	60W	L1095*W125*H120

# F60-6013



## PRODUCT FEATURES

Efficient, Isolated, brand driver  
 TRIAC 1-10V 2.4G DALI DALI-DT8 Dimming  
 High bright SMD chip, Lumen: 130lm/w

## STANDARD SURFACE COLOR



## DIMENSION

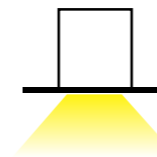
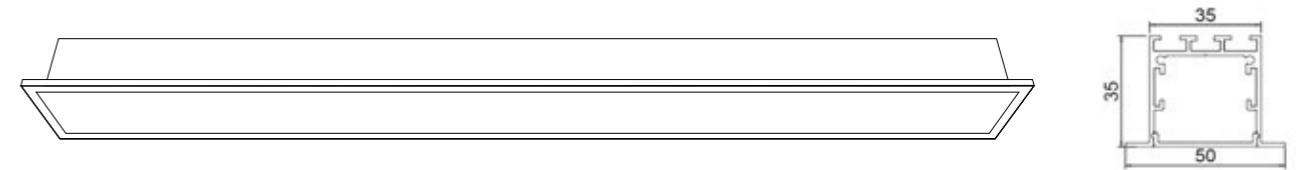

3000K 4000K 6500K

## PRODUCT SPECIFICATION

Voltage	DC36V
Factor	0.95
Light Source Flux	130lm/w
CRI	≥90
SDCM	≤3 STEPS
UGR	<10
Dimming	1-10V DALI OPTIONAL
IP/IK	IP20
Protection	CLASS III
Rated Lifespan	50,000 HOURS

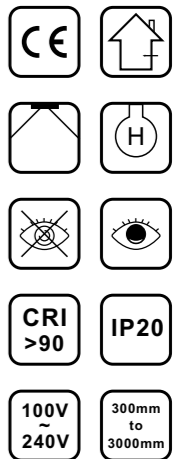

## PRODUCT PARAMETER

MODEL	LED OUPUT	POWER	SIZE(MM)
F60-6013	1950lm	15W	L606*W35
F60-6013	3900lm	30W	L1204*W35
F60-6013	5850lm	45W	L1803*W35
F60-6013	7800lm	60W	L2404*W35

F60-6014



**PRODUCT FEATURES**

Efficient, Isolated, brand driver  
 TRIAC 1-10V 2.4G DALI DALI-DT8 Dimming  
 High bright SMD chip, Lumen: 130lm/w

**STANDARD SURFACE COLOR**



**DIMENSION**

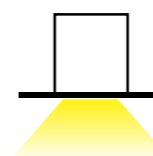
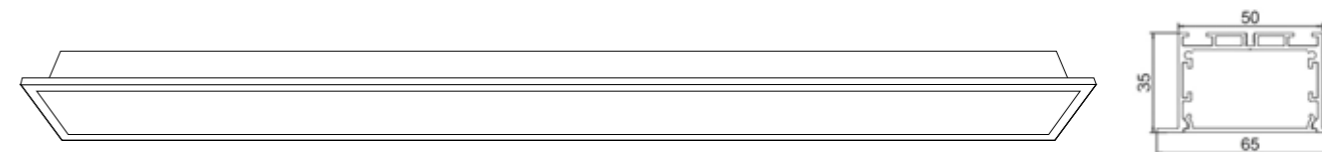

3000K 4000K 6500K

**PRODUCT SPECIFICATION**

Voltage	DC36V
Factor	0.95
Light Source Flux	130lm/w
CRI	≥90
SDCM	≤3 STEPS
UGR	<10
Dimming	1-10V DALI OPTIONAL
IP/IK	IP20
Protection	CLASS III
Rated Lifespan	50,000 HOURS

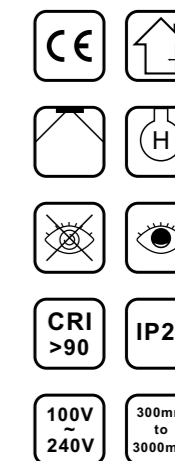

**PRODUCT PARAMETER**

MODEL	LED OUPUT	POWER	SIZE(MM)
F60-6014	1950lm	15W	L606*W50
F60-6014	3900lm	30W	L1204*W50
F60-6014	5850lm	45W	L1803*W50
F60-6014	7800lm	60W	L2404*W50

# F60-6015



## PRODUCT FEATURES

Efficient, Isolated, brand driver  
 TRIAC 1-10V 2.4G DALI DALI-DT8 Dimming  
 High bright SMD chip, Lumen: 130lm/w

## STANDARD SURFACE COLOR



## DIMENSION

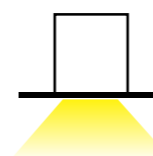
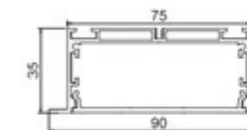
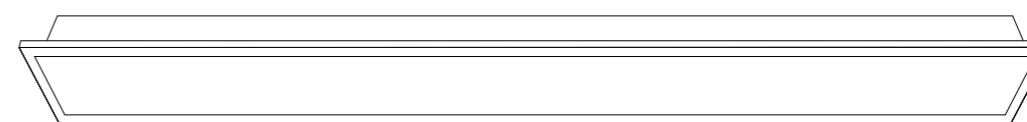

3000K 4000K 6500K

## PRODUCT SPECIFICATION

Voltage	DC36V
Factor	0.95
Light Source Flux	130lm/w
CRI	≥90
SDCM	≤3 STEPS
UGR	<10
Dimming	1-10V DALI OPTIONAL
IP/IK	IP20
Protection	CLASS III
Rated Lifespan	50,000 HOURS

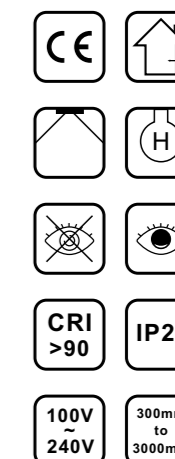

## PRODUCT PARAMETER

MODEL	LED OUPUT	POWER	SIZE(MM)
F60-6015	1950lm	15W	L606*W75
F60-6015	3900lm	30W	L1204*W75
F60-6015	5850lm	45W	L1803*W75
F60-6015	7800lm	60W	L2404*W75