



TNUT.AU

TNUT CLIMBING | May 2026 CATALOGUE | Version 18.2

remi@tnut.au | 0412 963 919 | IG: @tnutclimbing

500 CLIMBING HOLDS

MADE IN AUSTRALIA WITH RESISTANT POLYURETHANE



+

NEW VOLUMES



MONSTER SERIES

Gets everyone to the top.

E SERIES

Perfect comp holds.



DISK SERIES

Overgrown holds.

GEOMETRIC SERIES

Popular sets.



CLASSIC SERIES

All the essentials and more.



The Monster series not only targets beginner climbing with straightforward, super comfortable and ergonomic holds to get everyone to the top of the wall, it also assists climbers in transitioning from beginner to intermediate levels.



M00002

MIRRORED JUGS

\$101

2 large mirrored jugs to defy gravity.

Subtle incuts for better handling and wide steppable texture on one side of each hold.

Great on very steep walls but also super easy for beginners wearing sneakers on vertical walls.



3/8" BOLTS: 2 x 2-1/4"
M10 BOLTS: 2 x 55mm
SCREWS: 2 x 45mm

STYLE
COMFORT
POPULARITY

8 medium/large jugs.

Minimal protrusion for injury prevention.

Snag-free profiles to help with rope management.

Satisfying textured thumb placements.



3/8" BOLTS: 3 x 1-3/4", 5 x 2"
M10 BOLTS: 3 x 45mm, 5 x 50mm
SCREWS: 6 x 40mm, 3 x 45

M00004

VARIOUS FOOTHOLDS

\$75

5 small to medium varied
footholds perfect to go with
jugs and shallow jugs.

VARIETY
SIMPLICITY



3/8" BOLTS: TBC
M10 BOLTS: TBC
SCREWS: TBC

M00005

POSITIVE SCREW-ONS

\$84

12 screw-on fairly positive, pleasant and challenging small hand holds.

FINE DETAILS
4 to 5 FINGERS FIT
SURPRISINGLY ERGONOMIC

This set is often used for kid's climbing ramps for toddlers (Pikler Triangle).



SCREWS: 24 x 40mm

M00006



2 new holds upgraded in June 2025

\$200

STYLE
COMFORT
POPULARITY

8 medium-sized shallow jugs.

Minimal protrusion for injury prevention.

Snag-free profiles to help with rope management.

Satisfying textured thumb placements.

Great value.

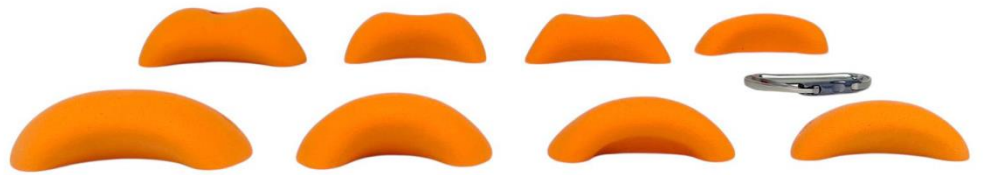
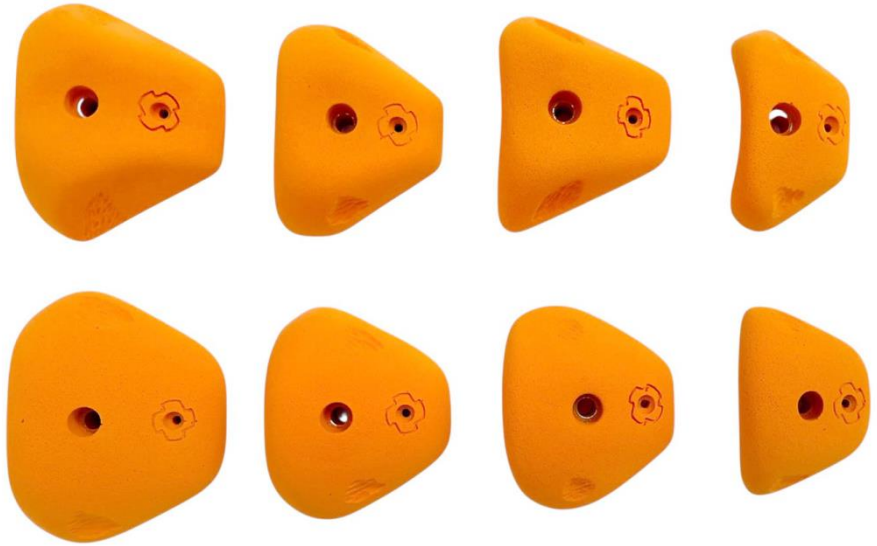

3/8" BOLTS: 1 x 1-1/2", 3 x 1-3/4",
4 x 2"
M10 BOLTS: 1 x 35mm, 1 x 40mm,
3 x 45mm, 3 x 50mm
SCREWS: 7 x 40mm, 1 x 45mm



M00008

BLOCKY FOOTHOLDS

\$294

8 large holds. Ideal as footholds on vertical terrain for beginners wearing sneakers.

Versatile hand holds with pleasant thumb placements and fingertip grips.



3/8" BOLTS: 1 x 2-1/4", 2 x 2-1/2",
4 x 2-3/4", 1 x 3"
M10 BOLTS: 1 x 55mm, 2 x 65mm,
4 x 70mm, 1 x 80mm
SCREWS: 2 x 40mm, 1 x 45mm, 2 x
50mm, 1 x 60mm, 1 x 80mm, 1 x
100mm

CALLING
COMFORT

4 large to very large incut
jugs of incremental rise.

Combine these super
comfortable jugs with a few
sets of M00002, M00003,
M00012 to create
easy/moderate climbs even
on steep terrain.

Note: One of these jugs (the
second biggest one) is
TNUT's down climbing hold -
See catalogue reference
#P00005.



3/8" BOLTS: 1 x 2-1/4", 2 x 2-1/2",
1 x 4"

M10 BOLTS: 1 x 55mm, 2 x 65mm,
1 x 100mm

SCREWS: 1 x 45mm, 1 x 50mm, 1 x
60mm, 1 x 70mm

M00010

VERSATILE HOLDS

\$170

8 versatile holds.

Hand holds:

Grade: 12-15 on vertical

Grade: V4-V6 on 40° wall

Perfect footholds for
beginners even wearing
sneakers.



3/8" BOLTS: 2 x 1-3/4", 2 x 2", 4 x 2-1/4"

M10 BOLTS: 2 x 45mm, 1 x 50mm, 5 x 55mm

SCREWS: 3 x 40mm, 5 x 60mm

M00011

POSITIVE HOLDS

\$198

8 just positive and ergonomic hand holds.

Minimal protrusion for injury prevention.

Snag-free profiles to help with rope management.

Satisfying textured thumb placements.

Hand holds:

Grade: 12-15 on vertical

Grade: V4-V5 on 40° wall



3/8" BOLTS: 2 x 2", 4 x 2-1/4", 2 x 2-1/2"

M10 BOLTS: 2 x 50mm, 4 x 55mm, 2 x 60mm

SCREWS: 4 x 40mm, 4 x 45mm

M00012

ROOF JUGS

\$480

8 ergonomic incut jugs.

These jugs were designed to be as economical as possible, yet providing ample room for a full hand.

Their generous incuts will feel deep and juggy even on roofs and very steep territories.

Minimal protrusion for injury prevention.

Snag-free profiles to help with rope management.

Satisfying textured thumb placements.



3/8" BOLTS: 5 x 2", 3 x 2-1/4"
M10 BOLTS: 5 x 50mm, 3 x 55mm
SCREWS: 7 x 40mm, 2 x 45mm, 2 x 50mm

M00013

EXTRA LARGE PINCHY JUGS

\$324

3 extra-large pinchy jugs.

Sizeable and matchable jugs with ergonomic handling for all fingers.

They are the most protruding holds of the Monster series.

Will also encourage heel hooks and provide ample space to push with a foot even on very steep terrains.



3/8" BOLTS: 1 x 2", 1 x 2-3/4", 1 x 3"

M10 BOLTS: 1 x 55mm, 1 x 65mm, 1 x 70mm

SCREWS: 3 x 60mm, 3 x 70mm



M00014

BEEFY SHALLOW JUGS

\$282

8 beefy shallow jugs.

Large holds with a perfectly satisfying robust grab.

Quite versatile at all angles and particularly fun for intermediate levels on 15° to 30° walls.



3/8" BOLTS: 2 x 2-1/4", 6 x 2-1/2"
M10 BOLTS: 2 x 55mm, 1 x 60mm,
5 x 65mm
SCREWS: 5 x 40mm, 2 x 45mm, 1 x
50mm

COMFORT
POSITIVITY
CONSISTENCY

8 medium-sized jugs.

Designed with minimal protrusion to reduce injury risk, these holds enable climbing/bouldering centers to create accessible routes and ladder-style climbs on vertical terrain, without interfering with often harder adjacent routes.

Satisfying textured thumb placements.

Great value.

An obvious choice for schools.



3/8" BOLTS: 2 x 1-1/2", 4 x 1-3/4",
2 x 2"

M10 BOLTS: 4 x 40mm, 2 x 45mm,
2 x 50mm

SCREWS: 5 x 30mm, 3 x 40mm



JUST THE RIGHT ANGLE & SURFACE

8 well calibrated footholds for beginner/intermediate climbers on vertical terrain and slightly steep walls.

Depths and angles make these holds discouraging enough as a hand hold, yet providing a usable foothold.

Combine with hand holds such as M00014, M00010, M00011.

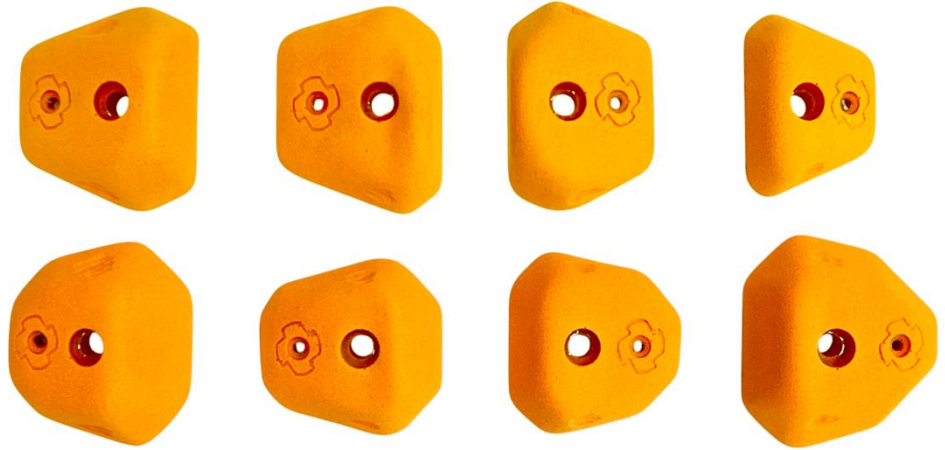

3/8" BOLTS: 7 x 1-1/2", 1 x 1-3/4"
M10 BOLTS: 2 x 35mm, 6 x 40mm
SCREWS: 4 x 30mm, 4 x 40mm

M00017



New set released in Feb 2025

\$180

ROOMY
MEDIUM
HOLDS

8 well calibrated medium footholds for beginner climbers on vertical terrain and slightly steep walls.

Ample surface area and angles make these holds a little discouraging as a hand hold for beginners, yet providing generous footholds.

Intermediate climbers will enjoy them as hand holds too.

Combine with hand holds such as M00003, M00006, M00010, M00013, M00015.

The bolt heads are exactly flush to the hold surface: no unplanned use of the bolt holes here!

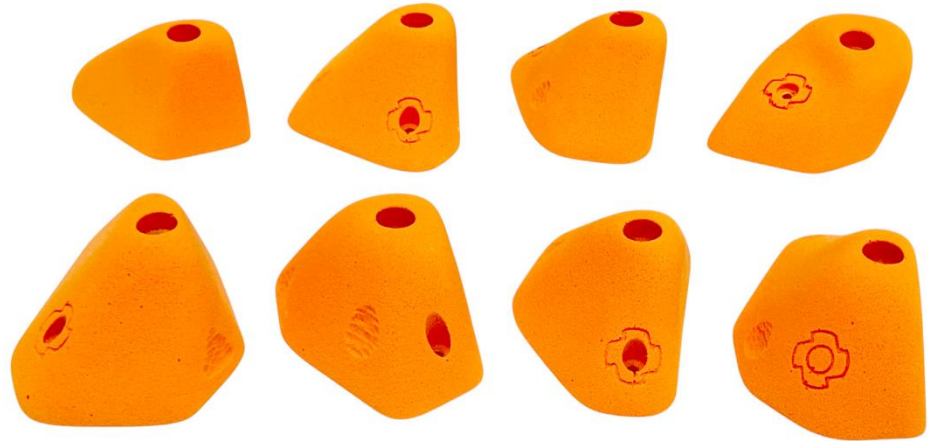

3/8" BOLTS: 2 x 2-1/4", 6 x 2-1/2"
M10 BOLTS: 1 x 55mm, 5 x 60mm,
2 x 65mm
SCREWS: 2 x 30mm, 5 x 40mm, 1 x
45mm



M00018



New set released in June 2025

\$185

WRAPABLE
MEDIUM
JUGS

This set of 8 medium jugs is perfect for beginners, offering a comfortable, *wrapable* handle. Ideal for routes on vertical walls and slightly overhanging terrain, these jugs instill confidence and help new climbers get to the top!

They also provide incredibly secure placement for your feet on steep terrain.

Combine with hand holds such as M00003, M00006, M00010, M00013, M00014, M00015...

A frequent choice for playground holds too.

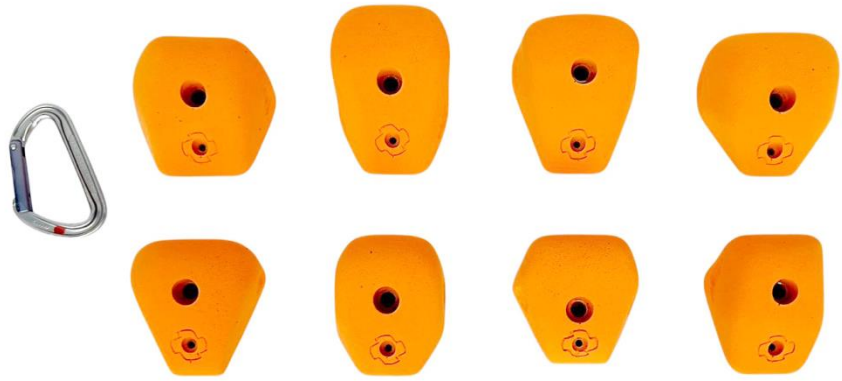

3/8" BOLTS: 1 x 1-3/4", 3 x 2", 3 x 2-1/4", 1 x 2-1/2"
M10 BOLTS: 1 x 45mm, 3 x 50mm, 3 x 55mm, 1 x 60mm
SCREWS: 6 x 40mm, 1 x 45mm, 1 x 50mm



M00020



3 new holds released in Jan 2025

\$179

SCREW-ON MEDIUM JUGS

8 medium-sized deep to shallow jugs

Minimal protrusion for injury prevention.

Snag-free profiles to help with rope management.

Satisfying textured thumb placements.

NOTE: Screw-on holds can be installed on any solid wooden panel. No need for t-nutted plywood.



All hollow backed since June 2025 !



SCREWS: 21 x 45mm, 3 x 50mm

M00021

SCREW-ON MINI JUGS

\$90

SCREW-ON MINI "JUGS"

8 small screw-on mini holds.

Minimal protrusion for injury prevention.

Snag-free profiles to help with rope management.

Satisfying textured thumb placements.

Home wall owners often get these to fill the gaps between t-nuts.

NOTE: Screw-on holds can be installed on any solid wooden panel. No need for t-nutted plywood.



SCREWS: 24 x 40mm

M00022



New set released in Feb 2026

\$348

CAMBERED JUGS

OPTIMAL FOR OUTDOOR PLAYGROUNDS

8 large holds designed specifically for outdoors.

Their base is cambered to let rain water naturally run off the sides of the holds, in all orientations.

They can be made to order as bolt-on holds or screw-on holds with either:

- 1 bolt hole + 3 screw holes
- 4 screw holes

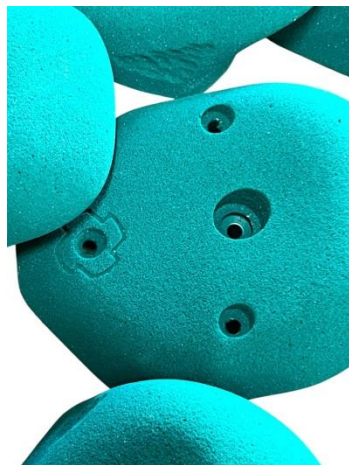

NOTE: Screw-on holds can be installed on any solid wooden panel. No need for t-nutted plywood. We highly recommend the use of Wurth screws on these large holds to improve stability.



3/8" BOLTS: TBC
M10 BOLTS: TBC
SCREWS: TBC



CAMBERED
GENEROUS
FOOTHOLDS

OPTIMAL
FOR OUTDOOR
PLAYGROUNDS

8 medium holds designed specifically for outdoors.

Their base is cambered to let rain water naturally run off the sides of the holds, in all orientations.

They can be made to order as bolt-on holds or screw-on holds with either:

- 1 bolt hole + 3 screw holes
- 4 screw holes

NOTE: Screw-on holds can be installed on any solid wooden panel. No need for t-nutted plywood. We highly recommend the use of Wurth screws on these large holds to improve stability.

3/8" BOLTS: TBC
M10 BOLTS: TBC
SCREWS: TBC

[PHOTOS COMING SOON]



The E series has been specifically designed for **competition** setting, where minute adjustments are required to reach a particular grade. The E series includes 16 sets of holds. Most sets of holds were shaped to cover the full spectrum of difficulty - from an easy to a difficult grab and 6 incremental angles in between. No doubt these tapered holds will be useful for both commercial setting and residential climbing walls.

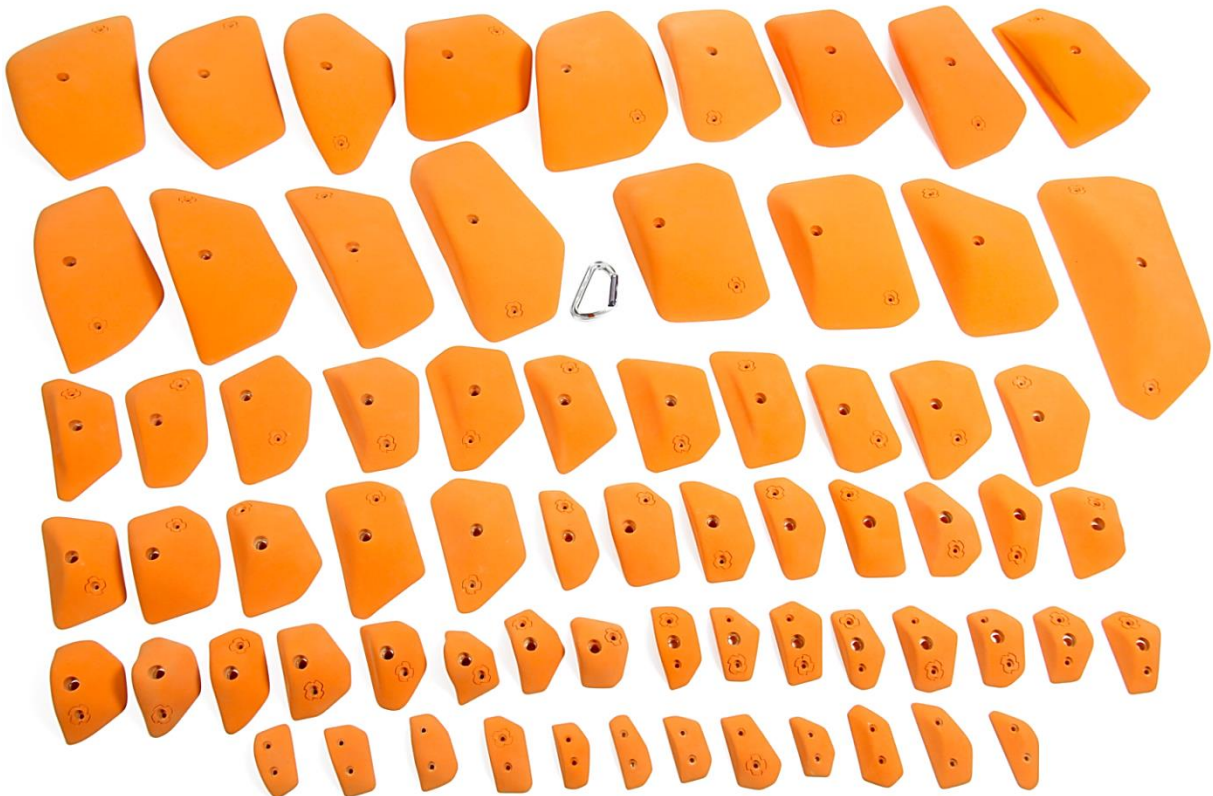

E01001

\$2237

8 overgrown holds,
8 degrees of difficulty,

HUGE
TAPERED
DIRECTIONAL

Length: 580mm
Width: 310mm
Depth: 100mm



3/8" BOLTS: 4 x 3", 4 x 4"
M10 BOLTS: 4 x 75mm, 4 x 100mm
SCREWS: 28 x 40mm, 4 x 45mm





8 very large holds,
8 degrees of difficulty.

CLEAN
ATTRACTIVE
DIRECTIONAL

Tip: combine with E00002
and E00003.

















These sets will present
themselves to the setter to
promptly create moves after
moves with well calibrated
holds.



3/8" BOLTS: 2 x 2-1/4", 2 x 2-1/2",
4 x 2-3/4"

M10 BOLTS: 4 x 60mm, 2 x 65mm,
2 x 70mm

SCREWS: 4 x 40mm, 4 x 45mm

8 very large holds,
8 degrees of difficulty fitting
in between the E00001
holds.

With this set, you can
efficiently reach the
optimum grade targeted.

CLEAN
ATTRACTIVE
DIRECTIONAL

Tip: combine with E00001,
E00003 and E00012 for best
visual impact on the wall.



3/8" BOLTS: 6 x 2-1/4", 2 x 2-1/2"
M10 BOLTS: 5 x 55mm, 1 x 60mm,
2 x 65mm

SCREWS: 3 x 30mm, 6 x 40mm



1 very large low profile hold with a similar footprint as E00001 or E00002 but a bit less to grab onto.

DIRECTIONAL
EYE-CATCHING
STRAIGHT EDGE

Tip: combine with E00001,
E00002 and E00012.



"Like it? Order it today to encourage TNUT to create a full set tomorrow."



3/8" BOLTS: 1 x 2-3/4"
M10 BOLTS: 1 x 70mm
SCREWS: 1 x 45mm

8 large holds with a curved edge fitting ergonomically along the fingertips.

Similar clean shapes as E00001 but about three times smaller.

LOW PROFILE
DIRECTIONAL
EVIL EDGES

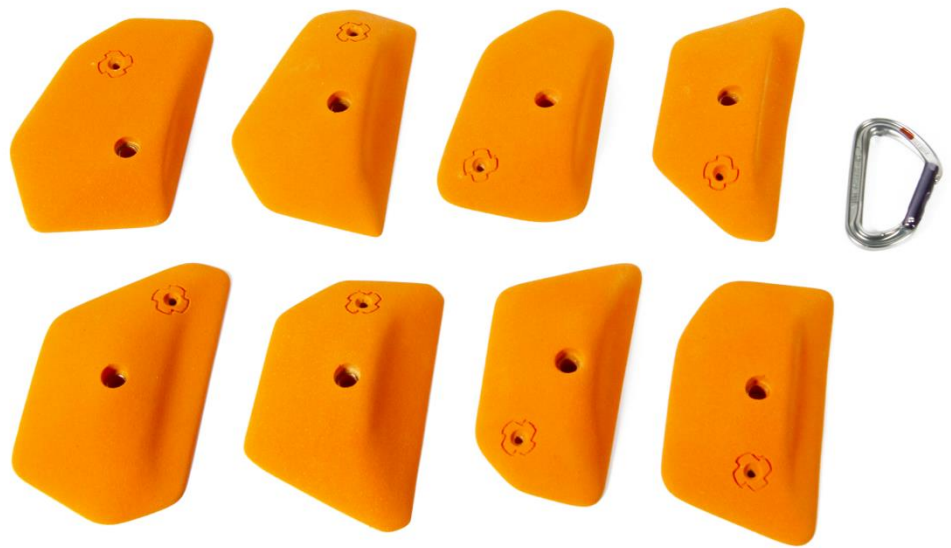

3/8" BOLTS: 6 x 1-1/2", 2 x 1-3/4"
M10 BOLTS: 5 x 35mm, 3 x 40mm
SCREWS: 6 x 30mm, 2 x 40mm

8 large holds including 3 decent edges and 5 slopers that may serve as decent footholds.

Similar clean shapes as E00001 but about three times smaller.

LOW PROFILE
NEAT EDGES
EVIL SLOPERS



3/8" BOLTS: 3 x 1-1/2", 3 x 1-3/4",
2 x 2"

M10 BOLTS: 1 x 35mm, 2 x 40mm,
3 x 45mm, 2 x 50mm

SCREWS: 3 x 30mm, 5 x 40mm

8 small edges and slopers of incremental difficulty.

Slightly less challenging than E00004 and E00005.

LOW PROFILE
FINGERPAD EDGES
NASTY SLOPERS



3/8" BOLTS: 2 x 1-1/4", 5 x 1-1/2",
1 x 1-3/4"

M10 BOLTS: 5 x 35mm, 3 x 40mm

SCREWS: 8 x 30mm

E00008

DISCONTINUED in April 2026 - See E00015...

Instead of the original set of 12 holds, we've extended the range into 2 sets of 8 holds, see E00015 & E00016.



E00009

DISCONTINUED in April 2026 - See E00017...

Due to their popularity, we now have 2 awesome sets on offer.

- One set of 8 sloppers to edge (E00017),
- Another set of 8 edges to crimps (E00018).



12 positive very small holds
ideal for accurate footwork
on a kickboard and steep
angles.



3/8" BOLTS: 3 x 1-1/4", 9 x 1-1/2"
M10 BOLTS: 3 x 35mm, 9 x 40mm
SCREWS: 12 x 30mm

CRIMPS ON STEEP

Dig in these 8 pleasant:
 - crimps on steep,
 - finger bucket on vertical.

These holds are simply stellar on roofs and very steep walls.



3/8" BOLTS: 1 x 1-1/2", 3 x 1-3/4",
 4 x 2"

M10 BOLTS: 1 x 40mm, 3 x 45mm,
 3 x 50mm, 1 x 55mm

SCREWS: 4 x 30mm, 4 x 40mm

8 challenging shallow and wide pinches.

V4-V6 on vertical,
V10-V15 on 10°/20° wall.

Choice of screw-on or bolt-on installation.

Tip: Combine these extra-large holds with similar sets such as E00001, E00002 and E00003.



3/8" BOLTS: 3 x 1-1/2", 5 x 1-3/4"
M10 BOLTS: 1 x 35mm, 5 x 40mm,
2 x 45mm
SCREWS: 18 x 30mm, 14 x 40mm

E00013



5 new holds released in Sept 2025

\$78

8 narrow, pointy and subtle edges.

Ideal as foot holds on slab, vertical and slightly steep walls.

Their narrow profiles offer fine to poor hand holds.

Interesting thumb catches when placed upside down.

POINTY
NARROW
ECONOMICAL



3/8" BOLTS: 8 x 1-1/2"
M10 BOLTS: 4 x 35mm, 4 x 40mm
SCREWS: 6 x 30mm, 2 x 40mm

E00014



1 new hold released in Sept 2025

\$114

8 medium protruding subtle edges.

These pleasant hand holds are fairly positive despite their small/medium sizes.

POSITIVE
VERSATILE
ECONOMICAL

Sept 2025 update: To address the high demand of this type of holds, TNUT kept the best ones from the now discontinued set of E00007 and created more (here and see E00013).

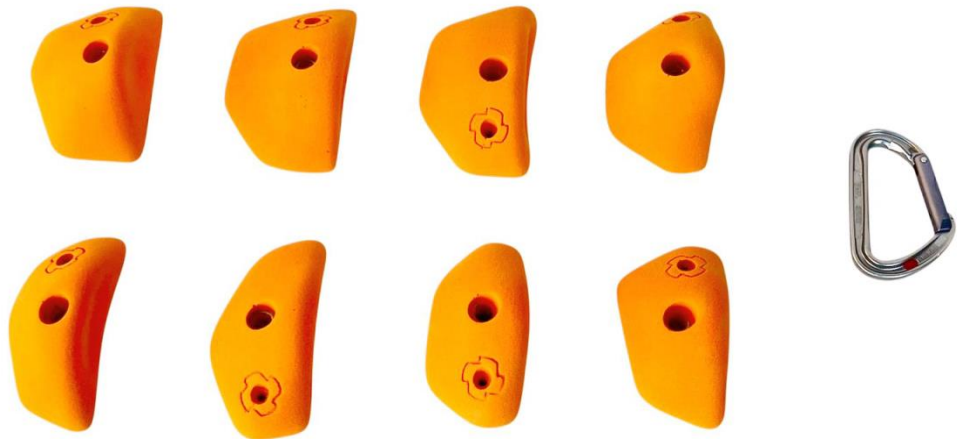
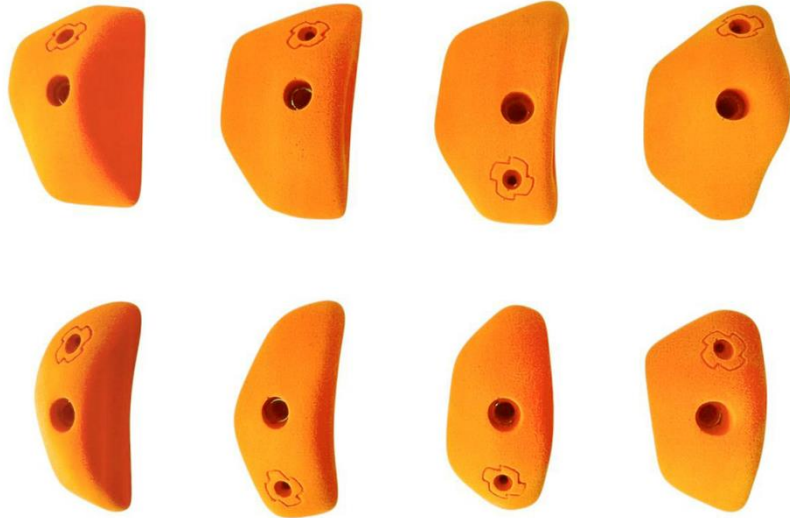

3/8" BOLTS: 3 x 1-1/2", 5 x 1-3/4"
M10 BOLTS: 6 x 40mm, 2 x 45mm
SCREWS: 4 x 30mm, 4 x 40mm



E00015



Few new holds released in April 2026

\$57

8 small sloppers to
"negative" edges of
incremental difficulty.

Choice of screw-on and bolt-
on attachment system.

ADAPTABLE
FLAT PROFILES
EDGES & SLOPERS



[NEW PHOTOS COMING SOON]

[NEW PHOTOS COMING SOON]

3/8" BOLTS: TBC
M10 BOLTS: TBC
SCREWS: TBC

E00016



Several new holds released in April 2026

\$66

8 small edges and crimps of incremental positivity.

Choice of screw-on and bolt-on attachment system.

ADAPTABLE
FLAT PROFILES
EDGES & CRIMPS



[NEW PHOTOS COMING SOON]

[NEW PHOTOS COMING SOON]

3/8" BOLTS: TBC
M10 BOLTS: TBC
SCREWS: TBC

E00017



Released in April 2026

\$36

8 screw-on jibs of incremental difficulty - ranging from just "negative" edges to a hold as flat as a stamp!

LOW PROFILE
SCREW-ON JIBS
NASTY FOOTERS



[NEW PHOTOS COMING SOON]

[NEW PHOTOS COMING SOON]

SCREWS: TBC

E00018



Several new holds released in April 2026

\$36

8 screw-on jibs of incremental difficulty - ranging from 1/2 finger pad decent crimp to a perfect edge.

LOW PROFILE
SCREW-ON JIBS
PERFECT EDGES
WICKED CRIMPS

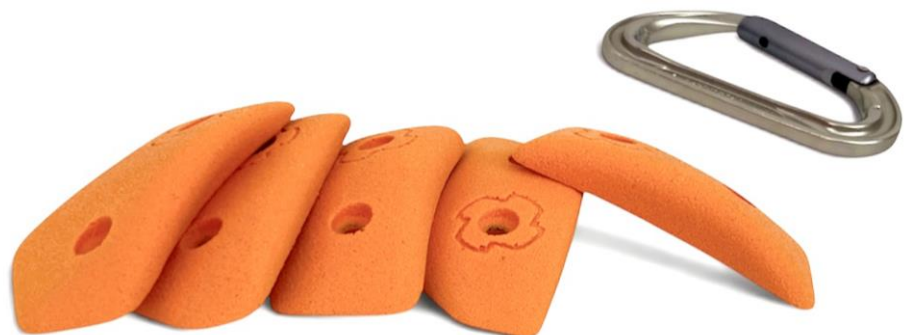
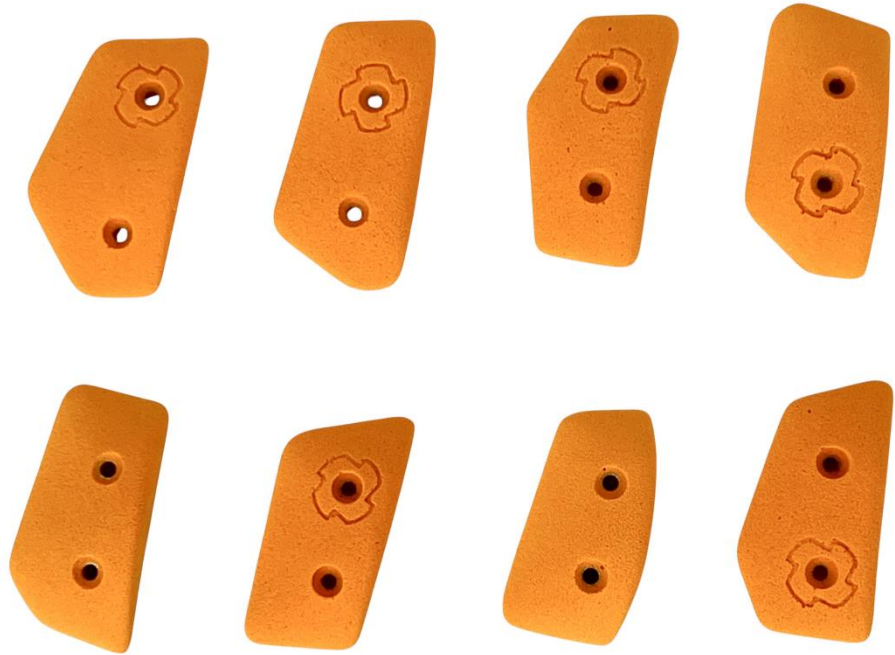

SCREWS: TBC



D01001

The FIREBALL

\$318

An ergonomic sloper turning to a gradually positive open hand. Matchable anywhere.

The narrow slot provides a decent 4-finger grab on the positive side. It is only cosmetic the other way.

It comes with screw-on blocker hold fitting perfectly in the narrow slot.

Length: 410mm
Width: 300mm
Depth: 100mm



3/8" BOLTS: 1 x 3-3/4"
M10 BOLTS: 1 x 100mm
SCREWS: 1 x 30mm, 1 x 40mm, 1 x 45mm, 1 x 80mm



Second largest overgrown hold from the disk series.

Orientation will determine whether the climber gets a matchable jug or a gnarly pinch.

Length: 420mm

Width: 320mm

Depth: 95mm



3/8" BOLTS: 1 x 3"

M10 BOLTS: 1 x 80mm

SCREWS: 1 x 60mm

G01001



\$262 (+ \$25 with the TNUT LOGO)

1 overgrown geometric hold with a fine wood grain texture. Gentle climbing will be paramount with this one.

Despite all appearances, it's made of polyurethane... not wood!

With a single bolt, it is convenient to install quickly on the wall during setting, subsequently add screws once in its final position.

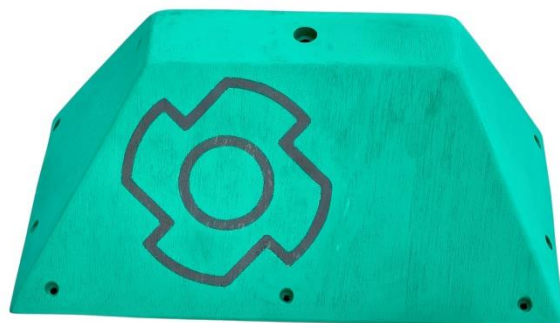

3/8" BOLTS: 1 x 6-1/2"
 M10 BOLTS: 1 x 160mm
 SCREWS: 7 x 40mm

G00001



2 holds added in Jan 2025

\$269

10 medium-large geometric pinches with detailed edges.

Prepare to be captivated by the detailed and intricate lines that define these exceptional holds. The GEO series is crafted for intermediate climbers, offering unconventional hand grips.

While versatile, they truly come alive on slightly steep-ish angles, from 10° to 45°.

Approximate grade range on vertical: 13 to 16.

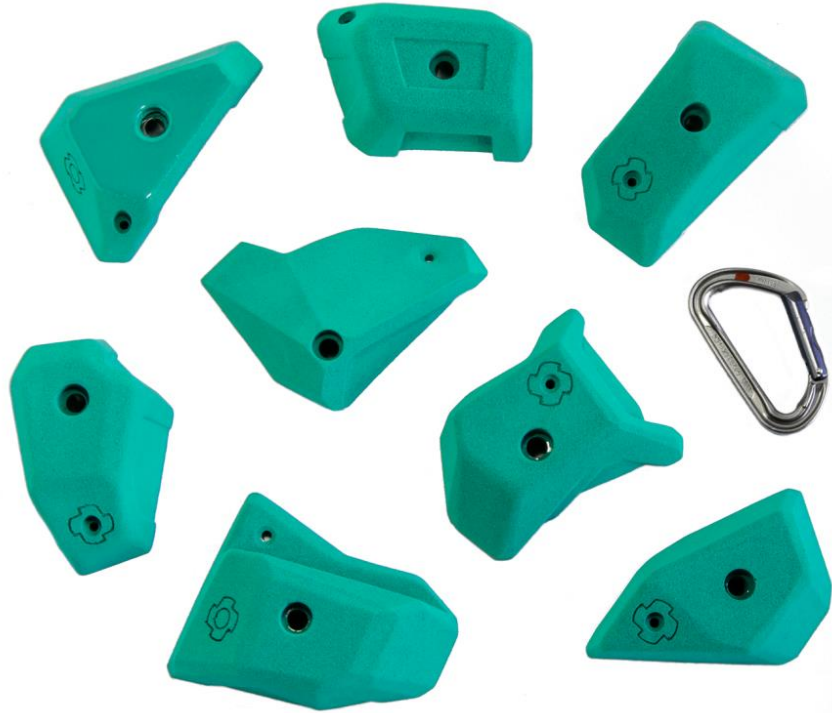

3/8" BOLTS: 1 x 2", 4 x 2-1/4", 5 x 2-1/2"

M10 BOLTS: 1 x 50mm, 3 x 55mm, 3 x 60mm, 3 x 65mm

SCREWS: 2 x 30mm, 1 x 40mm, 2 x 45mm, 3 x 50mm, 1 x 60mm, 1 x 70mm

The 2 holds added in Jan 2025

8 geometric medium-sized holds.

Sometimes it's nice NOT to know exactly what to expect from a climbing hold. These Geometric shapes take a bit of searching and feeling around to master.

Approximate grade range on vertical: 14 to 17.



3/8" BOLTS: 2 x 1-3/4", 4 x 2", 1 x 2-1/4", 1 x 2-1/2"

M10 BOLTS: 1 x 40mm, 1 x 45mm, 4 x 50mm, 1 x 55mm, 1 x 65mm

SCREWS: 1 x 30mm, 3 x 40mm, 4 x 45mm

G00003



7 new holds added in Jan 2025

\$132

12 small to medium holds, mostly footholds.

An affordable set to combine with G00001 and G00002.



3/8" BOLTS: 5 x 1-1/4", 5 x 1-1/2", 2 x 1-3/4"

M10 BOLTS: 7 x 35mm, 3 x 40mm, 2 x 45mm

SCREWS: 7 x 30mm, 5 x 40mm, 1 x 45mm

G00004

NEW

8 new jibs released in March 2025

\$36

8 protruding tiny screw-on footholds.

Length: ~45mm

Width: ~25mm

Height: ~20mm

Recently developed for accurate footwork on a 15° wall bouldering circuit.



SCREWS: 16 x 40mm



C00001



2 recently upgraded holds

\$479

8 deep very positive pinches.



3/8" BOLTS: 1 x 1-1/2", 2 x 2-1/4", 3 x 2-1/2", 2 x 2-3/4"
 M10 BOLTS: 1 x 40mm, 2 x 55mm, 3 x 65mm, 2 x 70mm
 SCREWS: 2 x 40mm, 2 x 45mm, 1 x 50mm, 2 x 60mm, 1 x 70mm



C00002

The PROPELLERS

\$422

BEAUTIFUL
EYE CATCHING

8 shallow ergonomic left
and right handed pinches.



3/8" BOLTS: 2 x 2", 1 x 2-1/4", 2
x 2-1/2", 2 x 2-3/4", 1 x 3-1/2"
M10 BOLTS: 1 x 45mm, 1 x
50mm, 2 x 60mm, 2 x 65mm, 1 x
70mm, 1 x 90mm
SCREWS: 1 x 30mm, 2 x 40mm, 4
x 45mm, 1 x 60mm

C01003

The IMPOSING PINCHES

\$1214

OVERGROWN
ERGONOMIC
INTRICATE

8 Imposing pinches that
won't disappoint!

Length: up to 560mm
Width: up to 200mm
Depth: up to 100mm

The ripples are
reminiscent of the
sandstone of Kalbarri in
Western Australia.

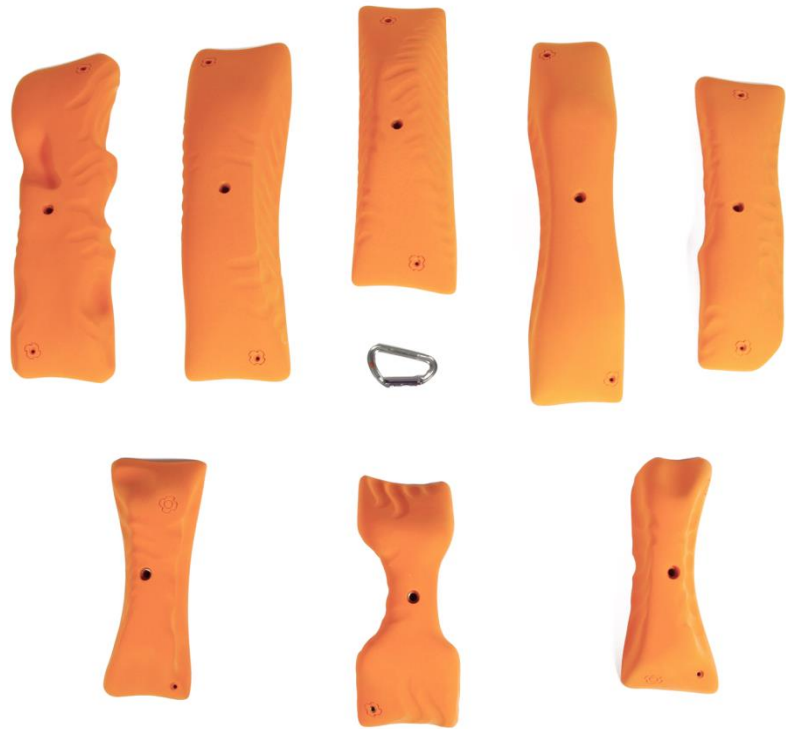

3/8" BOLTS: 1 x 2-1/2", 1 x 3", 1
x 3-1/2", 1 x 4", 4 x 4-1/2"
M10 BOLTS: 1 x 65mm, 1 x
70mm, 1 x 90mm, 1 x 100mm, 4
x 110mm
SCREWS: 10 x 45mm, 3 x 60mm

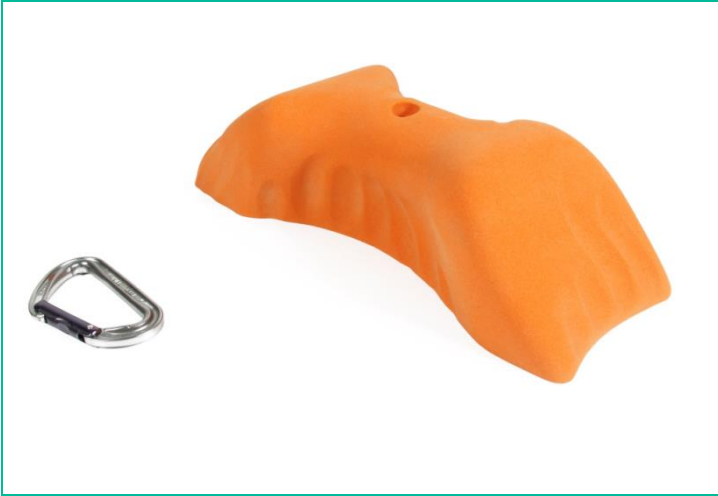

C00003



2 new blocks upgraded in Jan 2025

\$509

UNIQUE SHAPES
ERGONOMIC PINCHES
PRECISE HAND POSITIONS

8 Large pinchy holds. Narrow grooves force fingers' separation.

Thumb slots reveal decent pinches.

Tip: combine with C01003.



3/8" BOLTS: 8 x 2-3/4"
M10 BOLTS: 8 x 70mm
SCREWS: 2 x 45mm, 3 x 60mm, 2 x 70mm, 1 x 80mm

C00004

The CURVES

\$563

INVITING
IMPECCABLE
LARGE SLOPERS

12 slopers.

Optimal texture between
comfort and friction.

Excellent on low angles to
gentle overhangs.



3/8" BOLTS: 2 x 2", 2 x 2-1/2", 8 x 2-3/4"

M10 BOLTS: 2 x 50mm, 2 x 65mm, 8 x 70mm

SCREWS: 3 x 40mm, 1 x 45mm, 1 x 50mm, 2 x 60mm, 4 x 70mm, 1 x 80mm

C01005

The SHARK FAMILY

\$1752

FUN
POSITIVE
AESTHETIC
OVERSIZED
COMFORTABLE

With this absolutely unique set of 8 overgrown holds, novice and intermediate climbers will have inspiring lines to test their new skills on.

Length: 350-480mm
Width: 150-220mm
Depth: 80-110mm

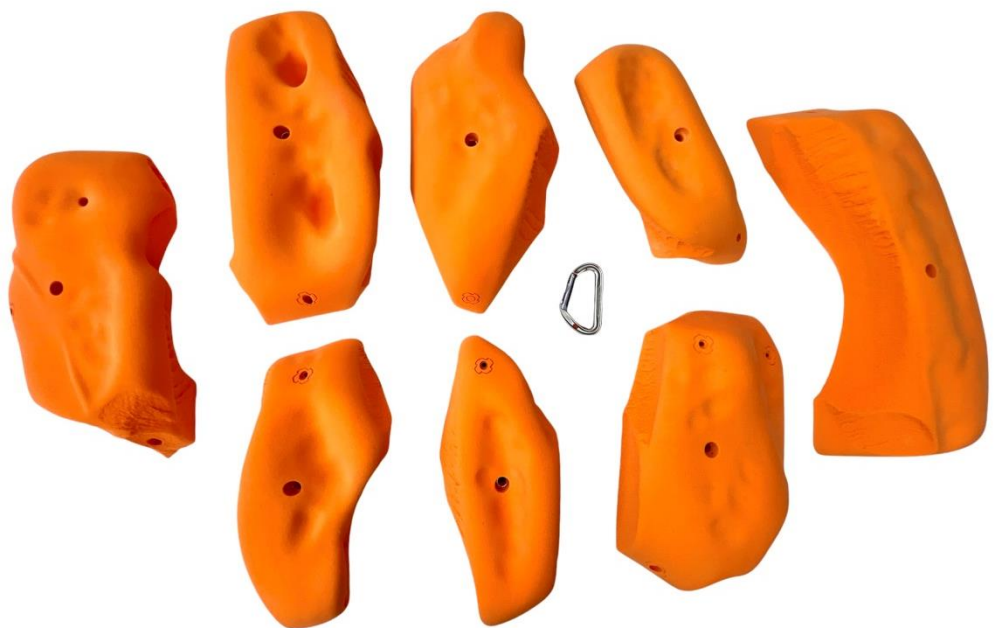

3/8" BOLTS: 1 x 2-1/2", 3 x 3-1/2",
3 x 4", 1 x 4-1/2"
M10 BOLTS: 1 x 70mm, 1 x 80mm,
2 x 90mm, 3 x 100mm, 1 x 110mm
SCREWS: 3 x 45mm, 1 x 50mm, 3 x
60mm, 5 x 70mm, 2 x 100mm

This hold is positive enough to be held at any angles.

Easy on vertical, very challenging on roofs.



A fantastic shape with two sweet spots to discover.

Easy on vertical, challenging on roofs.



This picture gave away the name of this set with the grip resembling a shark's jaw.

Easy on vertical, fairly challenging on roofs.



Simply our favourite hold in the whole catalogue! Super ergonomic and pleasant grab with a beautiful finish and a perfect hollow back.

Easy on vertical, fairly good on roofs.



A massive pinchable hold with deep thumb pockets that will force climbers to look for the best spot, one they may not find fast!

Good on vertical, difficult on roofs.

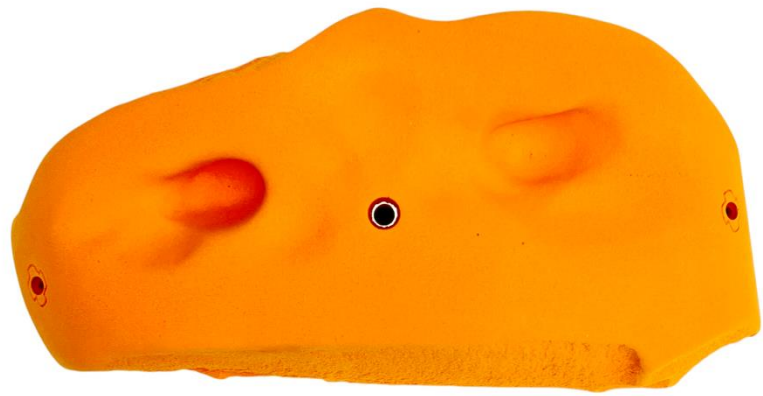

How juggy can a jug be?
How awesome can a hold feel?
How much attention to
details can be given to
obtain such a craft?

This hold is the answer.

Very easy on vertical, still
fairly easy on roofs.



This is the largest hold in the shark family: The hammer shark!

It features two deep four-finger pockets and ample space to step on to.

Easy on vertical, not so easy on roofs.



This hold has similar features as its siblings: hulky and lumpy!

Fine on vertical, extremely difficult on roofs.



"The shark family has been designed to be fairly easy to climb on. TNUT CLIMBING plans to extend the fam so support us now by ordering a set and let us know if you are interested in more."



C00005

The SWEET SPOTS

\$326

ATYPICAL
ERGONOMIC
GRATIFYING
LOVED BY MANY!

8 large holds with intricate
broken edges.

Find the single sweet spot
on every hold.

Comparably more positive
than the Classic Curves
(C00004).

A popular set for
intermediate/advance
climbers on 40° home walls.



3/8" BOLTS: 6 x 2-1/2", 2 x 2-3/4"
M10 BOLTS: 2 x 60mm, 4 x 65mm,
2 x 70mm
SCREWS: 1 x 30mm, 1 x 40mm, 1 x
50mm, 4 x 60mm, 1 x 70mm

C00006

The small Pinches

\$92

8 small straightforward pinches, often more positive one way than the other. Neat footholds.



3/8" BOLTS:
6 x 1-3/4", 2 x 2"
M10 BOLTS:
2 x 40mm, 6 x 45mm
SCREWS:
3 x 30mm, 5 x 45mm

C00007

The classic Pinches

\$345

12 medium to large straightforward pinches.



3/8" BOLTS: 1 x 1-3/4", 4 x 2", 3 x 2-1/4", 3 x 2-1/2", 1 x 3"
M10 BOLTS: 1 x 45mm, 2 x 50mm, 3 x 55mm, 3 x 60mm, 2 x 70mm, 1 x 75mm
SCREWS: 1 x 30mm, 6 x 40mm, 1 x 45mm, 2 x 50mm, 2 x 60mm



C00010A

The RAILS

\$310

8 visually appealing 30cm long rails allow more hand sequences.

Matchable pairs offer blocking opportunities.

Assorted textures provide a variety of feels.

Note: screws are mandatory for the installation.

Tip: combine them with C01003.



3/8" BOLTS: 3 x 1-1/4", 5 x 1-1/2"

M10 BOLTS: 8 x 35mm

SCREWS (mandatory): 4 x 30mm, 18 x 45mm

C00010B

The PLATES

\$198

4 matchable plates offer blocking opportunities.

4 textured flat footers.

Note: screws are mandatory for the installation of the matchable plates.



3/8" BOLTS: 6 x 1-1/4"
M10 BOLTS: 6 x 35mm
SCREWS (some mandatory):
20 x 40mm

C00011

The EDGES

\$182

SIMPLICITY
PERFECTION
DIRECTIONALITY

12 edges less than a
finger pad deep.

Challenging on steep
wall, fun on slabs.

Still too easy? Dare to
use the slopey side.

Another loved set!



*April 2026 Update:
C00011 moulds are
reaching their end of
life. TNUT Climbing is
progressively
discontinuing this set
and replacing it with
new shapes (similar to
the screw-ons from
C00026, just a touch
more challenging).
Expect some holds to
not be the exact same
ones as shown here.*



3/8" BOLTS: 1 x 1-1/4", 8 x 1-
1/2"

M10 BOLTS: 9 x 35mm

SCREWS (most mandatory):
13 x 30mm, 17 x 40mm

12 classic small rails.

Ideal to place on volumes and corners where standard bolt attachments are not available.

Most are just wide enough to match on.



SCREWS: 35 x 40mm

FOOTWORK
BODY TENSION

8 specialised footholds for
super steep walls.

Precise foot placements,
ideal to force moves such as
toe hooks and technical
bicycles on roofs.

Purposely NOT ergonomic!



3/8" BOLTS: 3 x 1-3/4", 1 x 2-1/4",
2 x 2-1/2", 2 x 2-3/4"

M10 BOLTS: 3 x 40mm, 1 x 55mm,
1 x 60mm, 1 x 65mm, 2 x 70mm

SCREWS: 1 x 45mm, 2 x 50mm, 2 x
60mm, 2 x 70mm

C00016

The SMILEYS

\$60

10 medium-sized holds
usable as small hand and
footers.



3/8" BOLTS: 4 x 1-1/4", 3 x 1-1/2",
1 x 2", 1 x 2-1/2"
M10 BOLTS: 4 x 35mm, 3 x 40mm,
1 x 50mm, 1 x 65mm
SCREWS: 1 x 30mm, 5 x 40mm, 2 x
45mm, 1 x 60mm

12 small to tiny rectangular edges of varying difficulty.



3/8" BOLTS: 3 x 1-1/2"
M10 BOLTS: 3 x 35mm
SCREWS: 14 x 30mm, 7 x 40mm

C00020

The TRIANGLES

\$32

REVOLUTIONISE
INDOOR CLIMBING

8 flat jibs of triangular
shape.

Add these jibs to your
setting arsenal.

Small sizes eliminate hand
hold options.

Help indoor climbers
practice good footwork.



SCREWS: 16 x 30mm

12 flat jibs providing technical climbing on slab, vertical and slightly steep terrain.



3/8" BOLTS: 2 x 1-1/2"
M10 BOLTS: 2 x 35mm
SCREWS: 20 x 30mm, 3 x 40mm

ACCURATE FOOTWORK

Small, sloped and very low profile jibs.

Ideal on volumes, corners and near vertical walls.

This set is the smallest in the TNUT CLIMBING range.

The Essential Ellipses are the exact size needed to place a foothold that will often be impossible to use as a handhold.



SCREWS: 25 x 30mm

12 flat square footholds.

Make smearing an obvious choice.



3/8" BOLTS: 1 x 1-1/4"
M10 BOLTS: 1 x 35mm
SCREWS: 29 x 30mm, 2 x 40mm

C00025



New "orphan" set, launched early 2025

\$200

Holds that don't belong to a set but are still great individuals.

Created at TNUT sometimes between 2016 and this year but haven't made it into a family (yet)...

15 very small to large holds to surprise you!

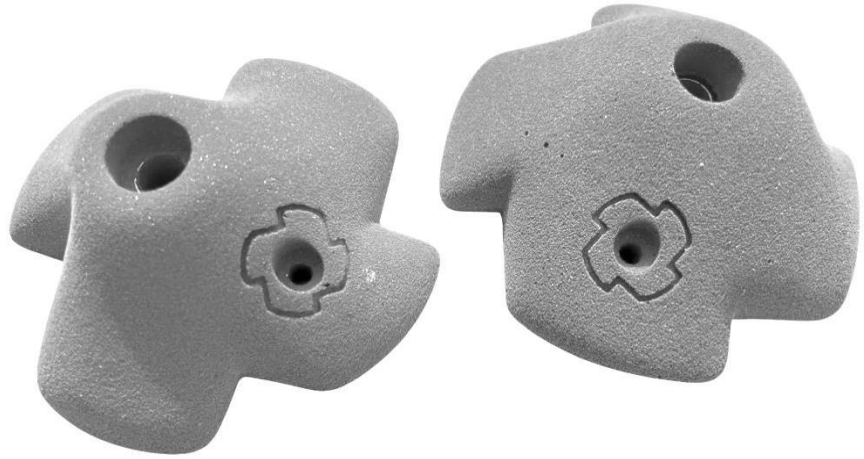

3/8" BOLTS: TBC
M10 BOLTS: TBC
SCREWS: TBC

C00026



8 new edges released in March 2025

\$171

SIMPLICITY
PERFECTION
DIRECTIONALITY

The success of set C00011 has led to the development of eight new edge holds, each a finger pad deep.

Targeted grade: V4-V5 on a 15 to 20 degrees wall.



SCREWS: 32 x 40mm



PACKS

TRAINING

PLAYGROUND

MERCH

GARMENT

HARDWARE

ANTI-CLIMBING MATS

WOODIES

COLOURS

TECHNICAL

4 STAY HOME PACKS OF CHOICE

Tell us the wall angle + level targeted, we'll select a range of holds that best fits your needs.

Shapes, colours, sizes and number of holds may vary depending on stock and production in the pipeline. In any cases, you'll get your money's worth!

The STAY HOME packs include regular black bolts: 3/8" or M10.

STAY20

STAY HOME PACK 20+ holds

\$488 - \$616

If you are on a budget and just want to get started, this is the pack for you.

Minimum 20 economical holds with fitted bolts.

More often than not, our customers come back for more!



STAY40

STAY HOME PACK 40+ holds

\$976 - \$1232

This pack is a solid foundation for your woody with a great variety of holds.

Minimum 40 holds with fitted standard bolts.



STAY60

STAY HOME PACK 60+ holds

\$1624 - \$1888

This is the ideal starter pack for your home climbing wall. It will get you psyched for years and may include larger visually appealing holds too!

Minimum 60 holds with fitted standard bolts.



STAY100

STAY HOME PACK 100+ holds

\$2640 - \$3120

This is the real deal to get you climbing strong.

Minimum 100 holds with fitted standard bolts.



P00005

STANDARD Downclimbing holds

\$330

Pack of 5 standard Down Climbing Holds.

TNUT's downclimbing hold made to perfection: comfortable, ergonomic, super juggy, aesthetic and easy to step on.

Make bouldering safer by adding a column of these holds to provide a safe way down.

These jugs are also excellent for easy grades on steep terrain or roofs.

Warning: Potentially addictive!

Available in the colour of your choice (commonly Standard grey RAL 7001, BASIC white-ish, etc...)



3/8" BOLTS: 5 x 2-1/2"
M10 BOLTS: 5 x 65mm
SCREWS: 5 x 60mm

P00006

LOW PROFILE Downclimbing holds

\$312

Pack of 5 low profile Down Climbing Holds.

A new addition to safety, designed with slab and vertical walls in mind.

Less protruding than our standard downclimbing hold, it's less likely to be in the way of climbers while slab climbing.

It has 3 screw-on holes and can be installed as a screw-on hold with a Lonestar when required.

These jugs are also excellent for easy grades even on steep terrain.

Available in the colour of your choice (commonly Standard grey RAL 7001, BASIC white-ish, etc...)



3/8" BOLTS: 5 x 1-3/4"
M10 BOLTS: 5 x 45mm
SCREWS: 15 x 40mm



Email remi@tnut.au with your requirements (preferred type of grip, wall angle, difficulty targeted...), we'll suggest a list of sets or individual holds.

Examples:

"I want 25 screw-on holds to add to an old and large tree",

"I have a budget of \$800 and want to be challenged at grade V8 on a 40° home wall",

"I want half a set of pretty pinches"...



T00001

Adjustable Wide Pinches

\$201

2 sets of parallel holds designed to work on pinch strength.

The position can be adjusted to the desired width (minimum 105mm).

Choice of 2 attachment systems: 3 long screws or 1 bolt.



3/8" BOLTS: 4 x 3"
 M10 BOLTS: 4 x 75mm
 SCREWS: 12 x 60mm

PLAYGROUND

3 beautifully crafted climbing holds for playground.



These playground holds use a 2 bolt attachment system that requires 2 x M10 or 3/8" bolts. These climbing holds are designed for playground or other public spaces where it is often a requirement to have at least 2 attachment points. They will never spin once properly installed. TNUT CLIMBING opted here for SIMPLE, SKIN-FRIENDLY and ERGONOMIC playground climbing holds. Don't be fooled by nonsensical, sharp playground holds made of cheap plastic and too often available on the market!



PG-HAND1

2 bolt playground HAND hold

\$30

This hold is great value, positive and provides plenty of comfort for little and big hands.

Minimum order applies.

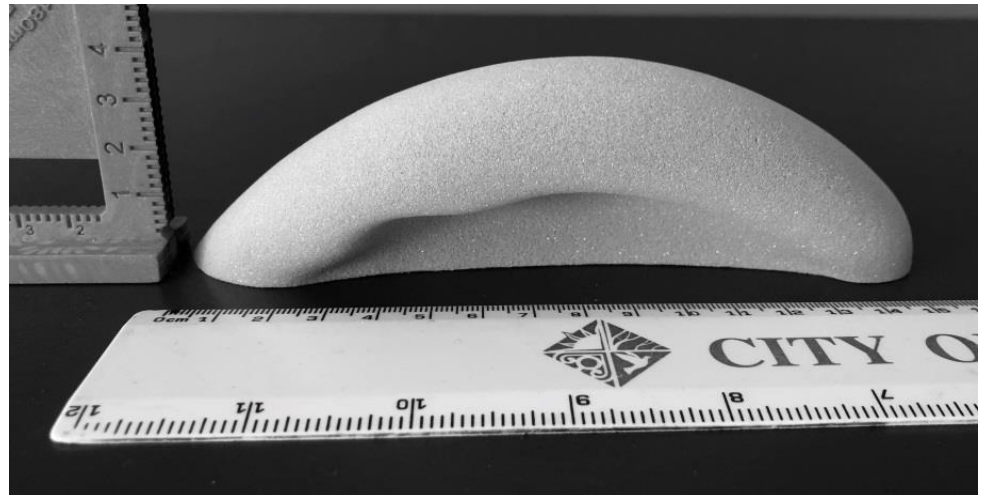
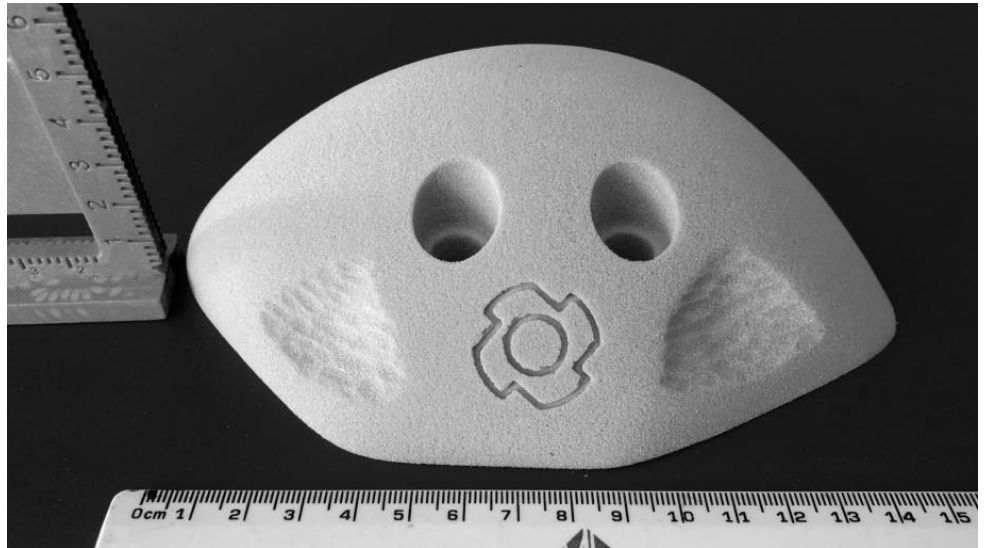
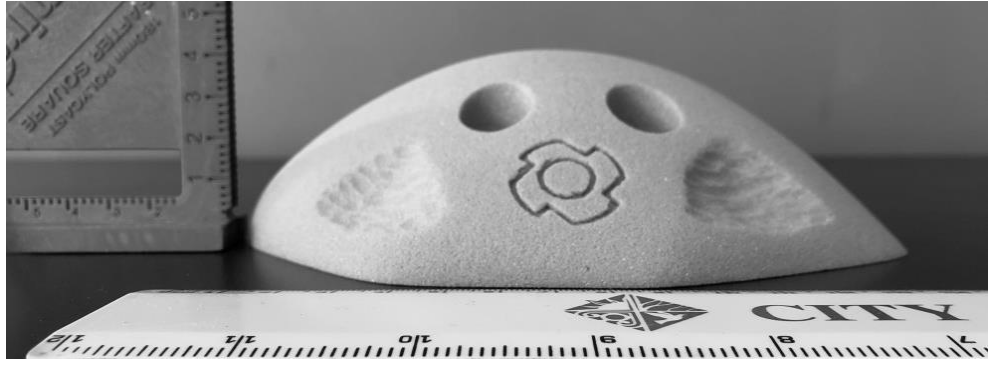

3/8" BOLTS: 2 x 2" (TBC)
M10 BOLTS: 2 x 50mm (TBC)

PG-FOOT1

2 bolt playground FOOTHOLDS

\$28

Beginners will find it equally easy to place a foot on this holds with or without specific climbing shoes.

It is also a very satisfying and positive hand hold with friendly thumb catches and an ergonomic curve.

Minimum order applies.

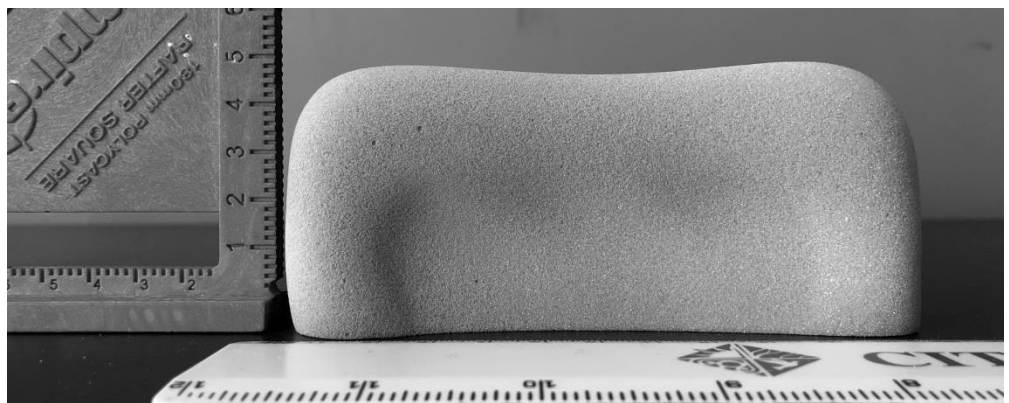
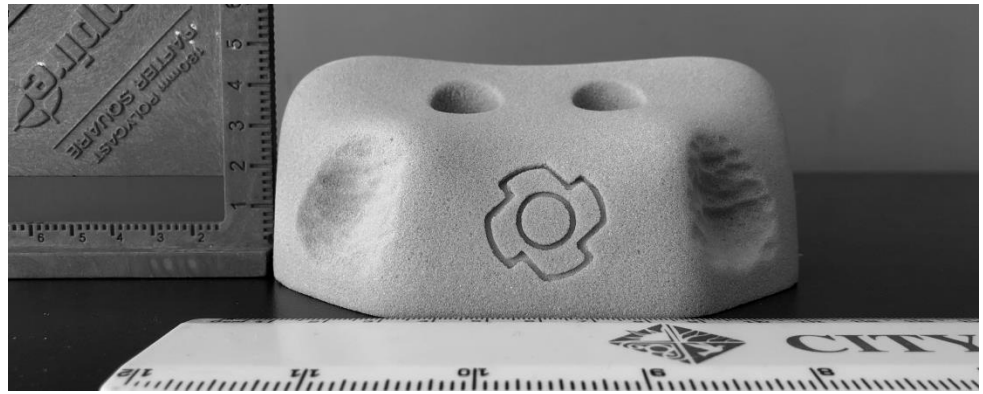

3/8" BOLTS: 2 x 2" (TBC)
M10 BOLTS: 2 x 50mm (TBC)

PG-15RG

Two-bolt 15cm campus rung

\$23

A straightforward, positive campus rung with a comfortable radius. Can be turned around for a more challenging grip.

Minimum order applies.

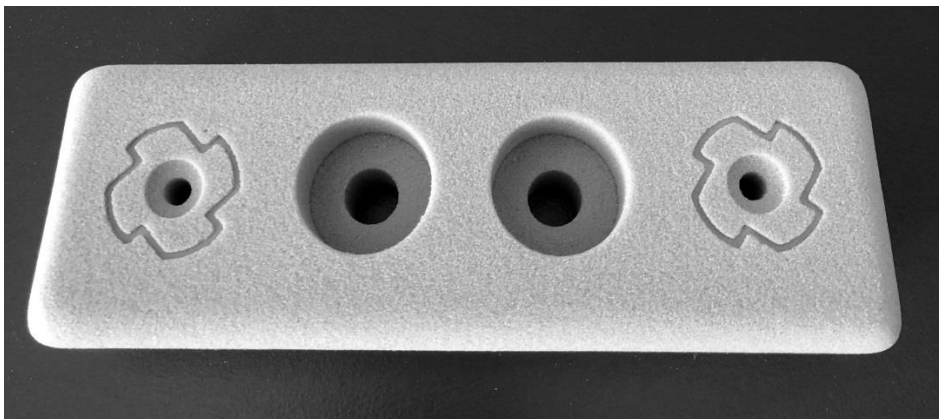
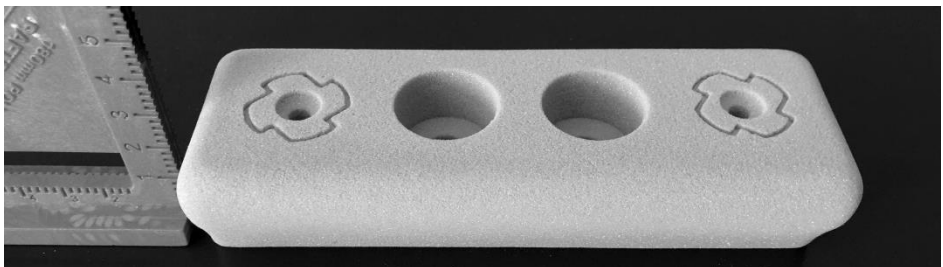
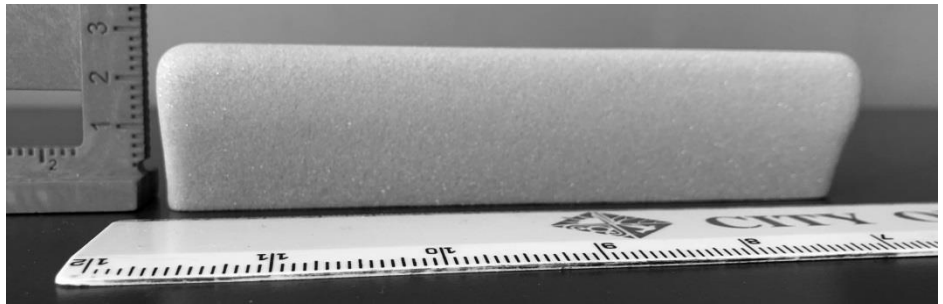

3/8" BOLTS: 2 x 1-3/4"
M10 BOLTS: 2 x 45mm
SCREWS: 2 x 60mm

KEY001**Large keyring****\$4**

Add this keyring to your set of keys. Show everyone you're a dedicated climber/boulderer!

Alternatively, you may wear it as a pendant?

Same comfortable texture as every other TNUT holds.

**KEY002****Long keyring****\$4**

Another slightly longer keyring.

May be used as a callus stone too!



RF0001

The pebble

\$45

Medium-large hold.

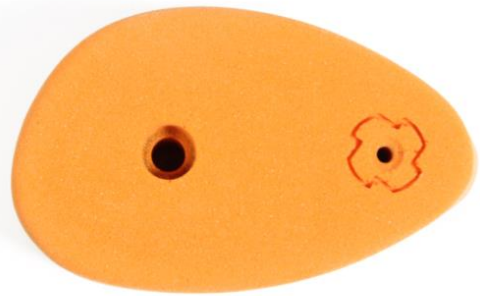

3/8" BOLTS: 1 x 2-3/4"
M10 BOLTS: 1 x 70mm
SCREWS: 1 x 80mm

CARDH1

Business card holder / phone holder

\$29

This is a 2-in-1 holder for business cards and smart phone.

Wall mounted or free-standing business card holder.

Wall mounted phone holder – handy when installed next to your training apparatus (hang board, campus board, ...). You'll never miss a set!



SCREWS: 1 x 45mm, 1 x 70mm



T-shirt & singlets

Limited stock only

GARMENT

Women's SINGLET

\$33

TNUT Women's singlet.

Premium apparel, regular fit, regular singlet shape.

Colour: Several

Size: XSM, SML, MED, LRG

Email remi@tnut.au for availability.



GARMENT**Women's T-SHIRT****\$33**

TNUT Women's t-shirt.

Premium apparel, slim fit, crew neck.

Colour: several

Size: XSM, SML, MED, LRG

Email remi@tnut.au for availability.

**GARMENT****Men's SINGLET****\$33**

TNUT Men's singlet.

Premium apparel, regular fit.

Colour: several

Size: SML, MED, LRG

Email remi@tnut.au for availability.



GARMENT

Men's T-SHIRT

\$33

TNUT Men's t-shirt.

Premium apparel, slim fit, crew neck.

Colour: several

Size: SML, MED, LRG

Email remi@tnut.au for availability.



To save time, effort, \$ and CO2 emissions, consider ordering a little extra t-nuts (10%) than you initially need.
 More often than not, our customers end up ordering twice to complete their build!

Zinc plated TEE NUTS (best for indoor use)

\$0.30 - \$0.34

Screw-in round based zinc plated t-nuts (including screws)

Thread: **3/8"**

Total height: 12.4mm
 Barrel height: 10mm
 Outside barrel diameter: 11mm
 Base thickness: 2mm
 Base diameter: 25mm

Size of drill bit required: 12mm



REF: 38ZPSIT-RND
 \$0.34 each



REF: B38ZPSIT-RND
 Box of 2000
 \$600 (\$0.3 each)

Screw-in round based zinc plated t-nuts (including screws)

Thread: **M10**

Total height: 13mm
 Barrel height: ~11mm
 Outside barrel diameter: 11.5mm
 Base thickness: ~2mm
 Base diameter: 25mm

Size of drill bit required: 12mm



REF: M10ZPSIT-RND
 \$0.34 each



REF: BM10ZPSIT-RND
 Box of 2000
 \$600 (\$0.3 each)

Stainless Steel TEE NUTS (outdoor use)

\$1.5

Screw-in round based
STAINLESS STEEL t-nuts
(including screws)

Thread: **3/8"**

Total height: ~12.7mm
Barrel height: 11mm
Outside barrel diameter:
11mm
Base thickness: ~2mm
Base diameter: 25mm

12mm drill bit required.



REF: 38SSSIT-RND
\$1.5 each

Screw-in round based
STAINLESS STEEL t-nuts
(including screws)

Thread: **M10**

Total height: 13mm
Barrel height: 11.3mm
Outside barrel diameter:
~11.8mm
Base thickness: ~2mm
Base diameter: 25mm

12mm drill bit required.



REF: M10SSSIT-RND
\$1.5 each

Industrial TEE NUTS (best for indoor use) - OUT OF STOCK

\$0.70 - \$0.75

Rectangular industrial zinc plated screw-in t-nuts (including screws):

Thread: **3/8"**

Rectangular base:
40mm x 25mm
Total height: 18mm
Barrel height: 15.7mm
Outside barrel \varnothing : 12.5mm
Base thickness: 2.2mm

Size of drill bit required:
12.5mm to 13mm



REF: 38ZPSIT-RECT
\$0.75 each
[OUT OF STOCK -
RESTOCKING TBC]



REF: B38ZPSIT-RECT
Box of 1000
\$700 (\$0.70 each)
[OUT OF STOCK -
RESTOCKING TBC]

Email remi@tnut.au to indicate your need.

Diamond industrial zinc plated screw-in t-nuts (including screws):

Thread: **M10**

Trimmed rectangular base:
40mm x 25mm
Total height: 18mm
Barrel height: 15.7mm
Outside barrel \varnothing : 12.5mm
Base thickness: 2.2mm

Size of drill bit required:
12.5mm to 13mm



REF: M10ZPSIT-DMD
\$0.75 each
[OUT OF STOCK -
RESTOCKING TBC]



REF: BM10ZPSIT-DMD
Box of 1000
\$700 (\$0.70each)
[OUT OF STOCK -
RESTOCKING TBC]

Email remi@tnut.au to indicate your need.

Industrial TEE NUTS (outdoor use) – MOQ APPLIES

\$2

Rectangular industrial
STAINLESS STEEL screw-in
t-nuts (including screws):

Thread: **3/8"**

Rectangular base:
40mm x 25mm
Total height: 20mm
Barrel height: 18mm
Outside barrel \varnothing : 12.5mm
Base thickness: 2.3mm
Holes \varnothing : 5mm
Certified material: SS G304

Size of drill bit required:
12.5mm to 13mm



[PRODUCTION ON
DEMAND, MINIMUM
ORDER of 20,000
APPLIES]

REF: 38SSSIT-RECT
\$2 each

REF: B38SSSIT-RECT
Box of 1000
\$1900

Email remi@tnut.au to indicate your need.

Diamond industrial
STAINLESS STEEL screw-in
t-nuts (including screws):

Thread: **M10**

Trimmed rectangular base:
40mm x 25mm
Total height: 18mm
Barrel height: 16mm
Barrel thread: 11mm
Self-guided barrel: 5mm
Outside barrel \varnothing : 12.5mm
Base thickness: 2mm
Holes \varnothing : 4.2mm
Certified material: SS G304

Size of drill bit required:
12.5mm to 13mm



[PRODUCTION ON
DEMAND, MINIMUM
ORDER of 20,000
APPLIES]

REF: M10SSSIT-DMD
\$2 each

REF: BM10SSSIT-DMD
Box of 1000
\$1900

Email remi@tnut.au to indicate your need.

Drill bits

\$25 - \$35

12mm or 12.5mm drill bits for standard drills.

Ideal for use in timber, plastic, ferrous and non-ferrous metals.

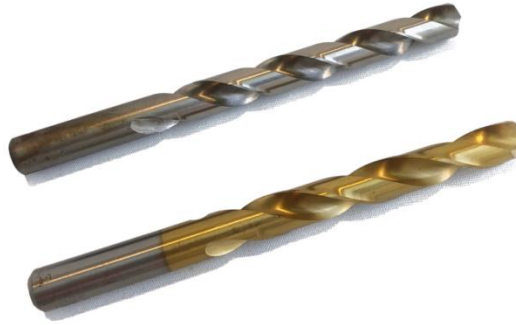

REF: 12DRILLBIT
12mm: \$25

REF: 125DRILLBIT
\$12.5mm: \$25

12mm or 12.5mm drill bits engineered for impact drivers with a 1/4" hex shank.

Ideal for use in timber, plastic, ferrous and non-ferrous metals.



REF: 12IMPACTBIT
12mm: \$30

REF: 125IMPACTBIT
12.5mm: \$35

Flush Anchors

\$2 - \$15

Mechanical M10 flush anchors to install directly on solid bricks and concrete walls.

Inner thread: Metric M10
Drill bit \varnothing required: 12mm

Carbon steel, zinc-plated
(for indoor/dry use)



REF: HZPFA1040
\$2

Stainless steel
(for outdoor use)



REF: HSSFA1040
\$15

3/8" High Tensile BOLTS (best for indoor use)

*indicative price only



1" 1/4 bolts	31.75mm	\$0.38
1" 1/2 bolts	38.1mm	\$0.43
1" 3/4 bolts	44.45mm	\$0.51
2" bolts	50.8mm	\$0.50
2" 1/4 bolts	57.15mm	\$0.54
2" 1/2 bolts	63.5mm	\$0.67
2" 3/4 bolts	69.9mm	\$0.74
3" bolts	76.2mm	\$0.82
3" 1/4 bolts	82.55mm	\$0.90
3" 1/2 bolts	88.9mm	\$1.02
3" 3/4 bolts	95.25mm	\$1.11
4" bolts	101.6mm	\$1.19
4" 1/2 bolts	114.3mm	\$1.56
5" bolts	127mm	\$1.59
5" 1/2 bolts	139.7mm	\$2.07

3/8" Countersunk BOLTS (best for indoor use)

*indicative price only



High Tensile COUNTERSUNK bolts UNC (Black). |

A 7/32" Allen key is required to tighten these countersunk bolts. Countersunk bolts are only needed for certain type of small climbing holds. You won't need these bolts with any TNUT holds.

1" 1/4 bolts	31.75mm	\$0.50
1" 1/2 bolts	38.1mm	\$0.60
2" bolts	50.8mm	\$0.95
2" 1/2 bolts	63.5mm	\$1.20
3" bolts	76.2mm	\$1.50

3/8" Stainless Steel G304 BOLTS (outdoor use)

*indicative price only



1" ¼ bolts	37.75mm	\$1.03
1" ½ bolts	38.1mm	\$1.43
1" ¾ bolts	44.45mm	\$1.51
2" bolts	50.8mm	\$2.02
2" ¼ bolts	57.15mm	\$2.25
2" ½ bolts	63.5mm	\$2.86
3" bolts	76.2mm	\$3.05
3" 1/2 bolts	88.9mm	\$4.75
4" bolts	101.6mm	\$4.05

3/8" Stainless Countersunk BOLTS (outdoor use)

*indicative price only



1" ½ bolts	38.1mm	\$1.24
1" ¾ bolts	44.45mm	\$1.46
2" bolts	50.8mm	\$1.90
2" ¼ bolts	57.15mm	\$2.45
2" ½ bolts	63.5mm	\$2.09
3" bolts	76.2mm	\$2.70

A 6mm allen key or impact bit is required to tighten these countersunk bolts. Countersunk bolts are only needed for certain type of small climbing holds. You won't need these bolts with any TNUT holds.

M10 High Tensile BOLTS (indoor use)

*indicative price only



35mm	\$0.42
40mm	\$0.49
45mm	\$0.55
50mm	\$0.61
55mm	\$0.64
60mm	\$0.67
65mm	\$0.75
70mm	\$0.82
75mm	\$1.03
80mm	\$1.24
90mm	\$1.32
100mm	\$1.39
110mm	\$2.03
120mm	\$2.20
140mm	\$4.25
160mm	\$6.23

M10 Stainless Steel G304 BOLTS (outdoor use)

*indicative price only



40mm	\$1.14
45mm	\$1.23
50mm	\$1.31
55mm	\$1.53
60mm	\$1.56
65mm	\$1.57
70mm	\$1.88
80mm	\$2.10
90mm	\$2.27
100mm	\$2.56
110mm	\$2.84
120mm	\$3.06

Other BOLTS

Enquiry by emailing remi@tnut.au

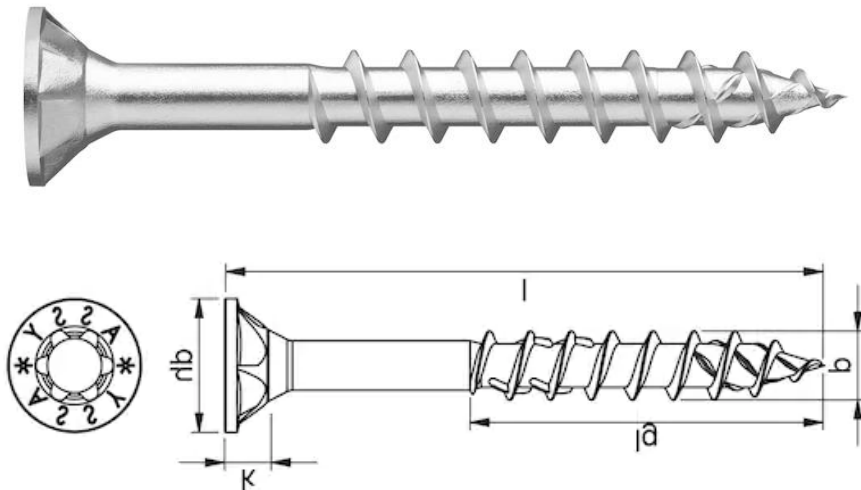

These WURTH screws combined with the RW20 bit are the best to install climbing holds to wooden panels with ease. Many climbing centres in Australia, Europe, Asia, etc have been using these screws in recent years and there is no going back!

The bit fits perfectly in the drive, ensuring a higher level of stability and precise positioning during the screwing process. Most importantly, screwing can be carried out much easier with one hand than most other types of wood screws. These save considerable time and energy to setters who already have to deal with balancing themselves on ladders and ropes.

Other sizes may be available on request, please email remi@tnut.au

WURTH4030 (per unit or box of 500)	∅: 4mm	L: 30mm	\$9.47
WURTH4540 (per unit or box of 500)	∅: 4.5mm	L: 40mm	\$19.62
WURTH4545 (per unit or box of 500)	∅: 4.5mm	L: 45mm	\$18.16
WURTH4550 (per unit or box of 500)	∅: 4.5mm	L: 50mm	\$21.25
WURTH4560 (per unit or box of 250)	∅: 4.5mm	L: 60mm	\$28.09
WURTH4570 (per unit or box of 500)	∅: 4.5mm	L: 70mm	\$32.28
WURTH4580 (per unit or box of 200)	∅: 4.5mm	L: 80mm	\$38.43
WURTH45100 (per unit or box of 100)	∅: 4.5mm	L: 100mm	\$49.06



WURTH STAINLESS STEEL WOOD SCREWS

*indicative price only (per 100)



No more rusty stains on your holds with these beautifully made WURTH screws made of stainless steel.

- Ease of installation,
- Time saving,
- Strong and secure,
- Durable and suitable for outdoors.

Other intermediate sizes available on request, please email remi@tnut.au

SSWUR4530 (per unit or box of 200)	ø: 4.5mm	L: 30mm	\$94
SSWUR4545 (per unit or box of 100)	ø: 4.5mm	L: 45mm	\$120
SSWUR4560 (per unit or box of 250)	ø: 4.5mm	L: 60mm	\$142
SSWUR4580 (per unit or box of 100)	ø: 4.5mm	L: 80mm	\$268



SCREWS BIT

WURTH ASSY RW20 BIT

\$6.25

Patented RW bit for Wurth ASSY screws.



The RW bit fits deep into the ASSY countersunk milling pocket head, providing maximum power transmission and allowing significant movement of the impact driver with the screw placed at the tip of the bit.

Compatible with impact drivers ($\frac{1}{4}$ inch hex attachment).

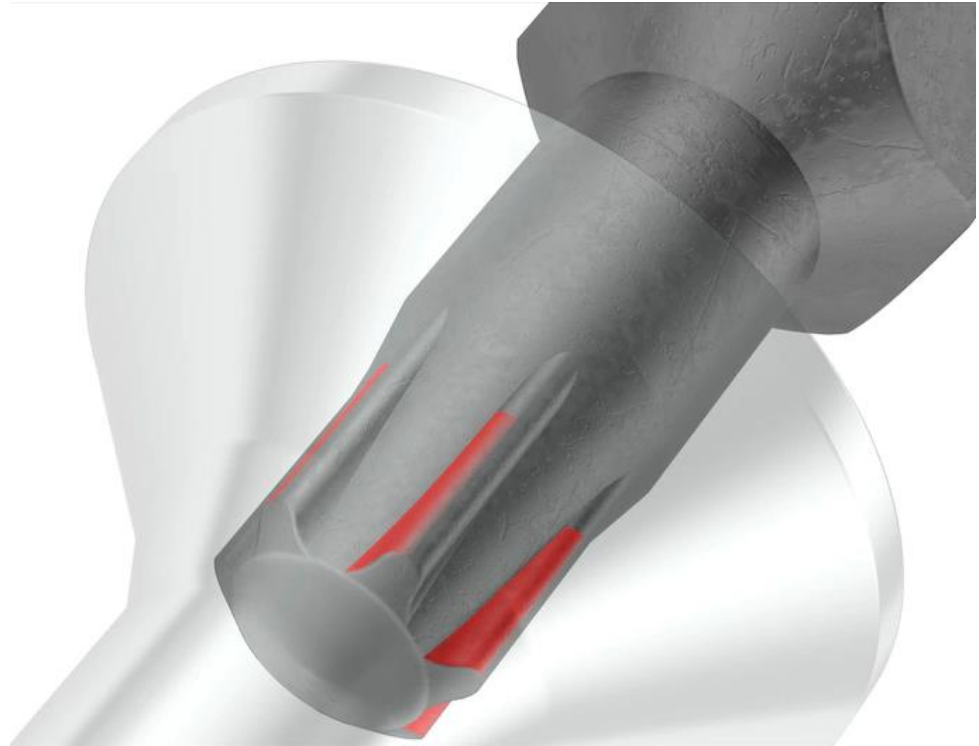
The RW20 is also compatible with previous internal drive AW20.



ROUTE SETTING ESSENTIALS

<p>Impact driver bits for 3/8" standard bolts (compatible with M10 bolts)</p> <p>2" Impact Driver 5/16" bits</p> <p>3" Impact Driver 5/16" bits</p>		<p>REF:</p> <p>516IMPACT2</p> <p>516IMPACT3</p>	<p>\$9</p> <p>\$15</p>
<p>Impact driver bits for countersunk bolts</p> <p>Impact Driver 7/32" bits</p> <p>Impact Driver 6mm bits</p>	<p>[OUT OF STOCK - RESTOCKING ON DEMAND]</p> <p>[photo will be added here soon]</p>	<p>REF:</p> <p>732IMPACT</p> <p>6IMPACT</p>	<p>\$7</p> <p>\$8</p>
<p>5/16" hex T handle bar for standard bolts.</p>		<p>REF:</p> <p>516TBAR</p>	<p>\$25</p>

Escape Climbing Lonestar (TM)

No t-nut? No problem. Install holds anywhere with just screws.

Converts bolt holes into screw holes.

For professional routesetters only. Not all holds can be installed with the Lonestar.



REF:

LONESTAR

\$1.35

Volume Inserts



REF:

VOLINSERT

\$1

[OUT OF STOCK - RESTOCKING ON DEMAND]

ANTI-CLIMBING MATS

Custom-made, Durable, Safe and Secure System

The anti-climbing mat system has 2 functions:

- 1) Provides an impact attenuating system beneath the climbers when placed on the floor.



- 2) Prevents unsupervised climbing when secured across the wall.



Public will not be able to access the wall while the mat is up as it covers all possible hand and footholds up to 2.7m high.

Once placed on the floor, the mat straps can be tucked away easily, making the mat obstacle free.

The TNUT “no climbing” decal shows the climbing wall is closed.

Several colours available.



It features an ingenious key locking mechanism which guarantees only authorised members can bring the mats to the floor.

A simple key is used to access the wall. No specific tools required.

Email remi@tnut.au for a free quote.



VOLUMES



Well thought-out volumes that fit superbly together. With consistent sides of 400mm, 800mm or 1200mm, setters can naturally position TNUT volumes on climbing walls to create the coolest lines! Did we mention that many volumes are even stackable?

Plywood:

High grade 19mm structural ply

Finish:

Durable paint or varnish, textured or not

Attachment points:

Reinforced with inserts

TNUT's special feature:

Option to narrow the insert recess hole down to the diameter of the head of a standard screw (10mm) rather than the standard 12.5mm. This is to reduce the use of the attachment point by clever fingers!



T-nuts:

M10 or 3/8", zinc plated or stainless steel

Frequency of production:

Quarterly

Next production batch:

TBC

SMALL:

DALTONS 400

SQTONS 400

LARGE:

BUZZTON 800

POINTON 1200

JAMTON 1200

MEDIUM:

POINTON 800 SYMMETRICAL

POINTON 800 OFFSET

VERY LARGE:

VAULTON 800

TRAPTON 1200

DALTONS

8 x small volumes

From \$195 per volume

Starts at \$1700 for the full set of 8 volumes



The DALTON series features 8 small volumes of incremental rise.

From the sloppy 40 degrees to the steep 57.5 degrees (and every incremental of few degrees in between: 42.5°, 45°, 47.5°, 50°, 52.5°, 55°).

The footprint on the wall is an equilateral triangle of 400mm x 400mm x 400mm

When they aren't on the wall, their nesting design saves precious storage space in the hold room.

All TNUT volumes are fitted with **screw-in t-nuts**:



- M10 Zinc plated or,
- M10 Stainless Steel or,
- 3/8" Zinc plated or,
- 3/8" Stainless Steel



The DALTON 40° is the less protruding of the 8 volumes
(the shortest of the Daltons!).



DALTON 40° dimensions:
400mm x 400mm x 400mm
x 96mm

T-NUTS: 3

SCREWS: 6 x 45mm

The DALTON 45°, an all-round classic.

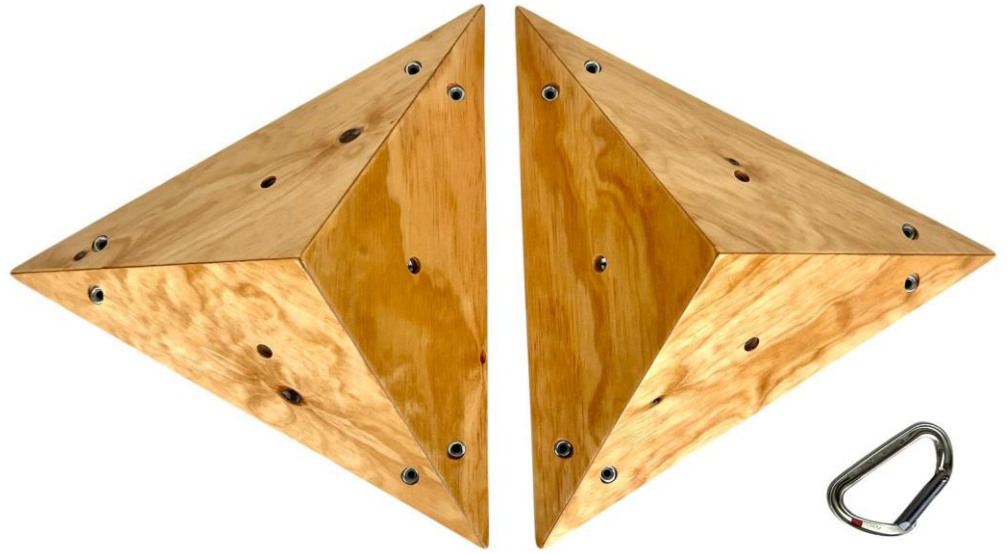

DALTON 45° dimensions:
400mm x 400mm x 400mm
x 115mm

T-NUTS: 3

SCREWS: 6 x 45mm

The DALTON 57.5°, for a more radical change of angle
(the tallest of the Daltons!)



DALTON 57.5° dimensions:
400mm x 400mm x 400mm
x 181mm

T-NUTS: 3

SCREWS: 6 x 45mm

A close up view of the standard 12.5mm recess screw hole versus the narrower custom hole of 10mm, significantly less usable.

STANDARD SCREW HOLE: 12.5mm



A nice addition to limit the potential unintended use of volume screw holes.

This feature is available upon request on all TNUT volumes.

CUSTOM REDUCED SCREW HOLE: 10mm

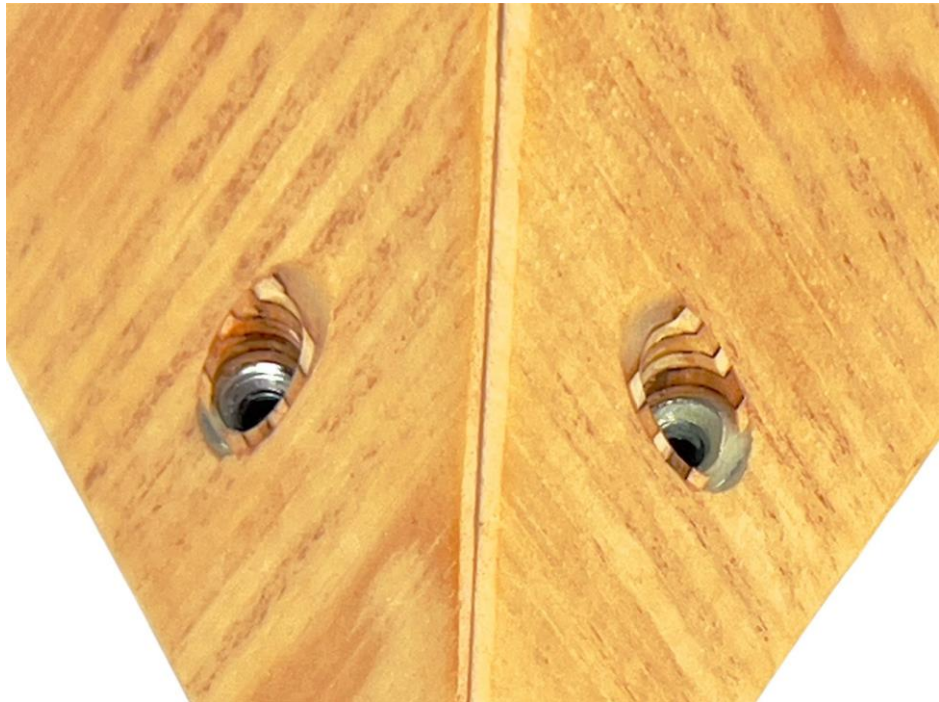

2 DALTONS placed adjacent of a SQTON.



SQTON

1 x small volume

Starts at \$275

This volume is called SQTON ("SquareTon"). It is shaped like a 4-sided pyramid with a chopped top.

Versatile on all terrain, it can not only be installed with screws but also with 1 central bolt for a quick installation while setters work out its final position on the wall.

Attachment points:

- 8 x 7mm screw holes reinforced with inserts
- 1 x 10.2mm hole reinforced with a G316 stainless steel washer.



SQTON dimensions:
400mm x 400mm x 400mm
x 125mm

3/8" BOLTS: 1 x 6"

M10 BOLTS: 1 x 160mm

T-NUTS: 4

SCREWS: 8 x 45mm



POINTON 800

2 x medium-sized volumes

Starts at \$295 each

POINTON 800 SYMMETRICAL

A handy medium-sized volume to vary the angle just when needed.

A great addition to your setting arsenal.



POINTON 800
SYMMETRICAL dimensions:
800mm x 400mm x 800mm
x 100mm

T-NUTS: 9

SCREWS: 9 x 45mm (TBC)



POINTON 800 OFFSET

Another solution to add some variation to the climbing without too much protrusion.



POINTON 800 OFFSET
Dimensions:
800mm x 400mm x 800mm
x 100mm

T-NUTS: 9

SCREWS: 8 x 45mm (TBC)



The **POINTON 800** placed next to a **DALTON**.



The **POINTON 800 SYMMETRICAL** stacked on top of the **POINTON 1200 SYMMETRICAL**.



A **POINTON 800**, a **SQTON** and a **DALTON** placed adjacent to each other.



The **BUZZTON** and a **POINTON 800** were design to point in the same direction, while lining up perfectly.



POINTON 1200

1 x large volume

Starts at \$450

The POINTON 1200 SYMMETRICAL:

With a large dimension of 1200mm x 100mm x 1200mm x 800mm and a low profile, this volume will make any walls look inviting to climb.

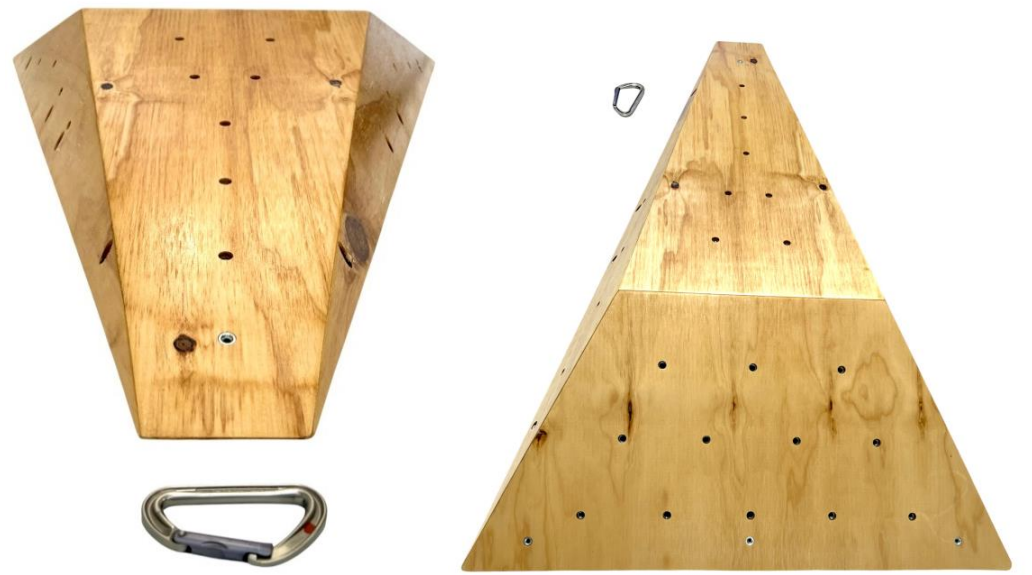

POINTON 1200 dimensions:
1200mm x 800mm x
1200mm x 100mm

T-NUTS: 27
SCREWS: 11 (length TBC)

JAMTON

2 x large volumes

Starts at \$475 each

The **JAMTONs** are two mirrored volumes that can be placed together to create a crack. It's deep enough to allow a full hand in.



JAMTON dimensions:
800mm x ~1200mm x
400mm x 800mm

T-NUTS: 22

SCREWS: 12 (length TBC)



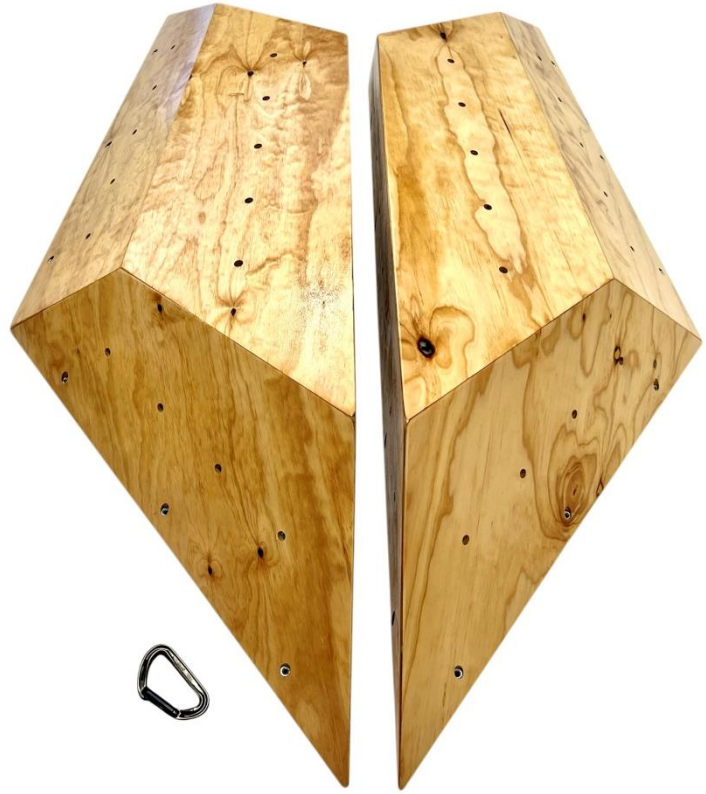

BUZZTON

1 x large volume

Starts at \$495

The **BUZZTON** is bulky, geometric powerhouse designed to redefine wall topography.

This large-scale pentagonal volume is built for setters who want to create forced movement, powerful compression, or simply to ease a steep terrain.

With its symmetrical profile and broad faces, it's as much a structural feature as it is a climbing hold, depending on its orientation and texture chosen.

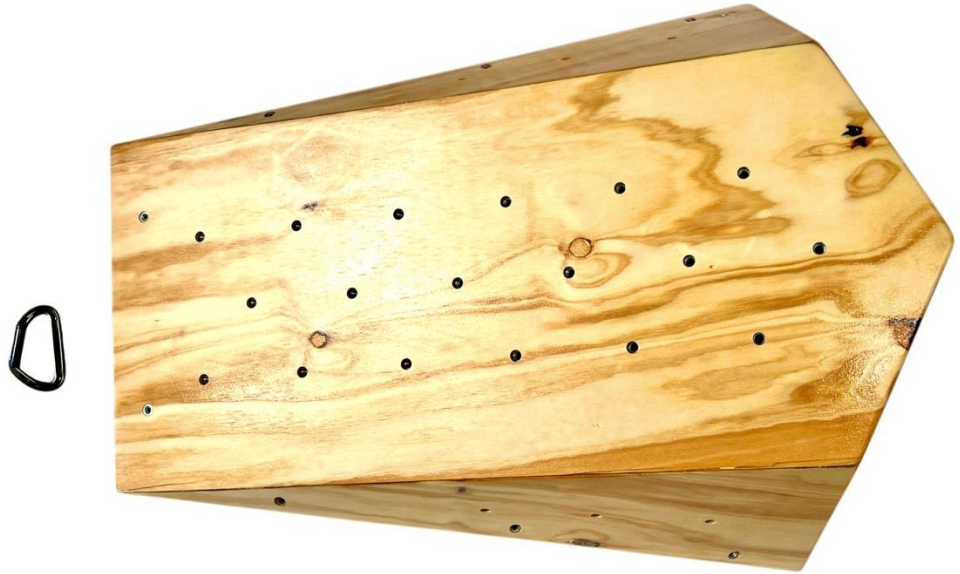

BUZZTON dimensions:
800mm x 400mm x 800mm
x 400mm x 400mm

T-NUTS: 26

SCREWS: 10 (length TBC)

VAULTON

1 x very large volume

Starts at \$595

The **VAULTON** is a mammoth diamond shape sturdy, boxy platform that projects significantly from the wall.

Roof and overhang can eat these for breakfast, lunch and dinner!

Its flat top makes it perfect for setting big, low-percentage dynos away from the wall.

What about high-tension mantles on easier ground?



VAULTON dimensions:
Base: 800mm x 800mm x
800mm x 800mm
Top: 400mm x 400mm x
400mm x 400mm

T-NUTS: 41

SCREWS: 12 (length TBC)

A **DALTON** stacked atop the **VAULTON**.



More **DALTONS** fitting nicely on all sides of the **VAULTON**.



The **TNUT CLIMBING** logo neatly visible on the **VAULTON**.



TRAPTON

1 x very large volume

Starts at \$750

The **TRAPTON** is high profile volume designed to transform flat wall panels into complex 3D climbing environments.

Perfect for parkour-style coordination moves.

A vertical wall can be turned into a series of precarious "steps" - offering a balancy traverse.

This is currently the biggest TNUT volume and it features not less than 54 t-nuts, so plenty of room to maximise its use on a bouldering or climbing wall.



TRAPTON dimensions:
Base: 1200mm x 800mm x
800mm x 800mm

T-NUTS: 54

SCREWS: 12 (length TBC)



These are the 8 **DALTONS** mimicking the footprint of one TRAPTON, for scale.



You have a project or an idea to build a small climbing wall at home, but don't know where to start?
We might be able to help... Email remi@tnut.au

Kid's climbing wall / storage unit

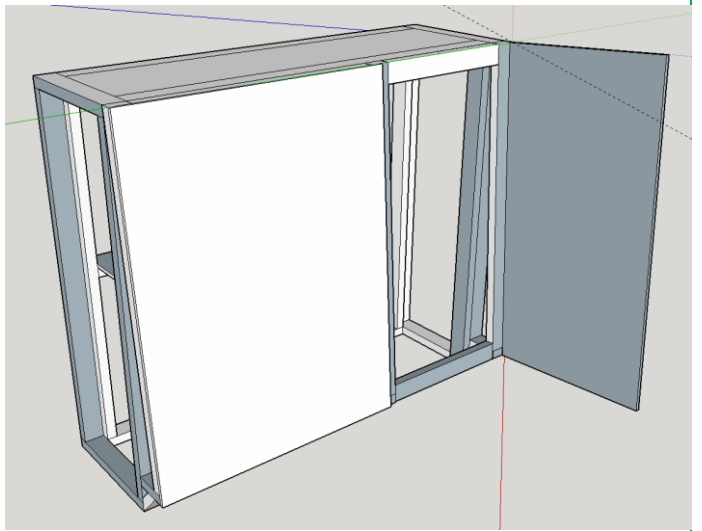
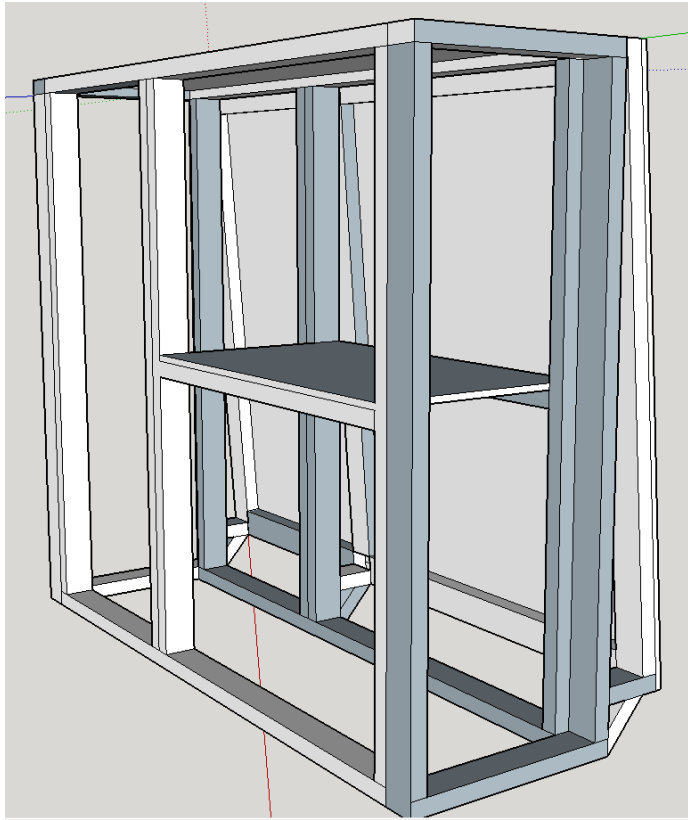

Toddler outdoor climbing frame

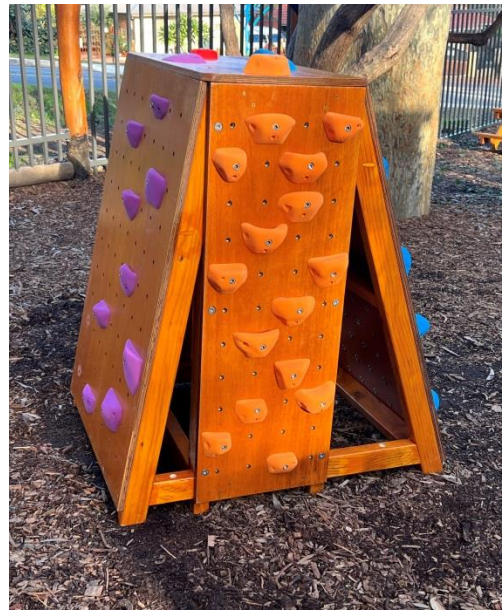
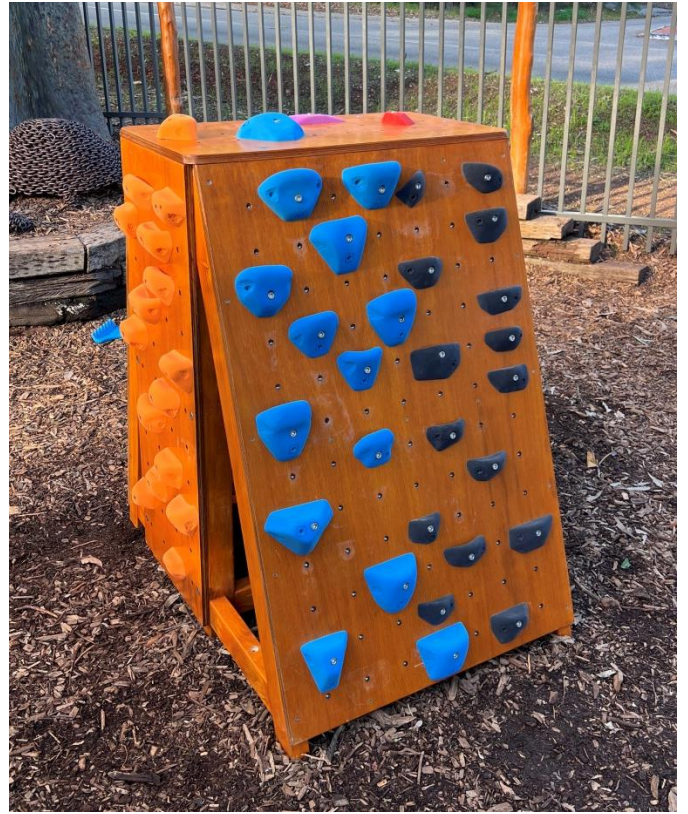

Vertical walls

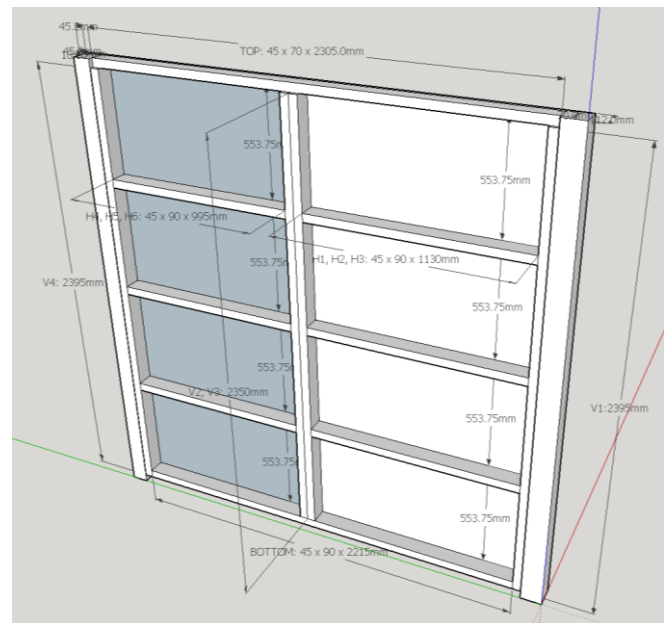
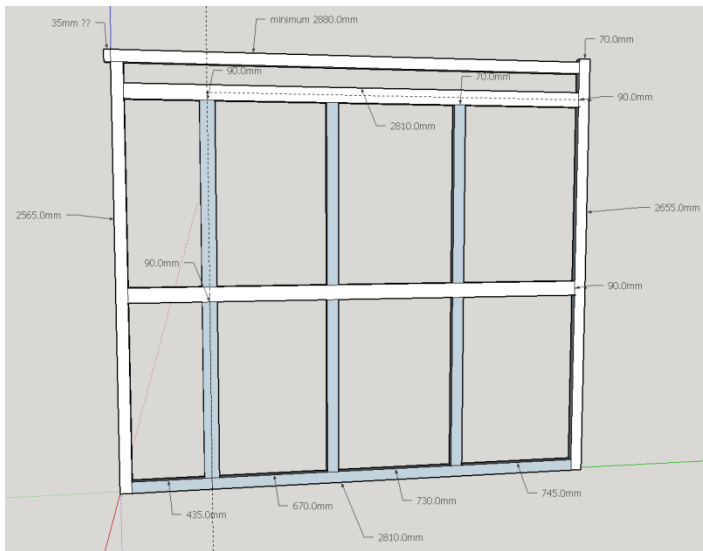

Standard MOONBOARD walls

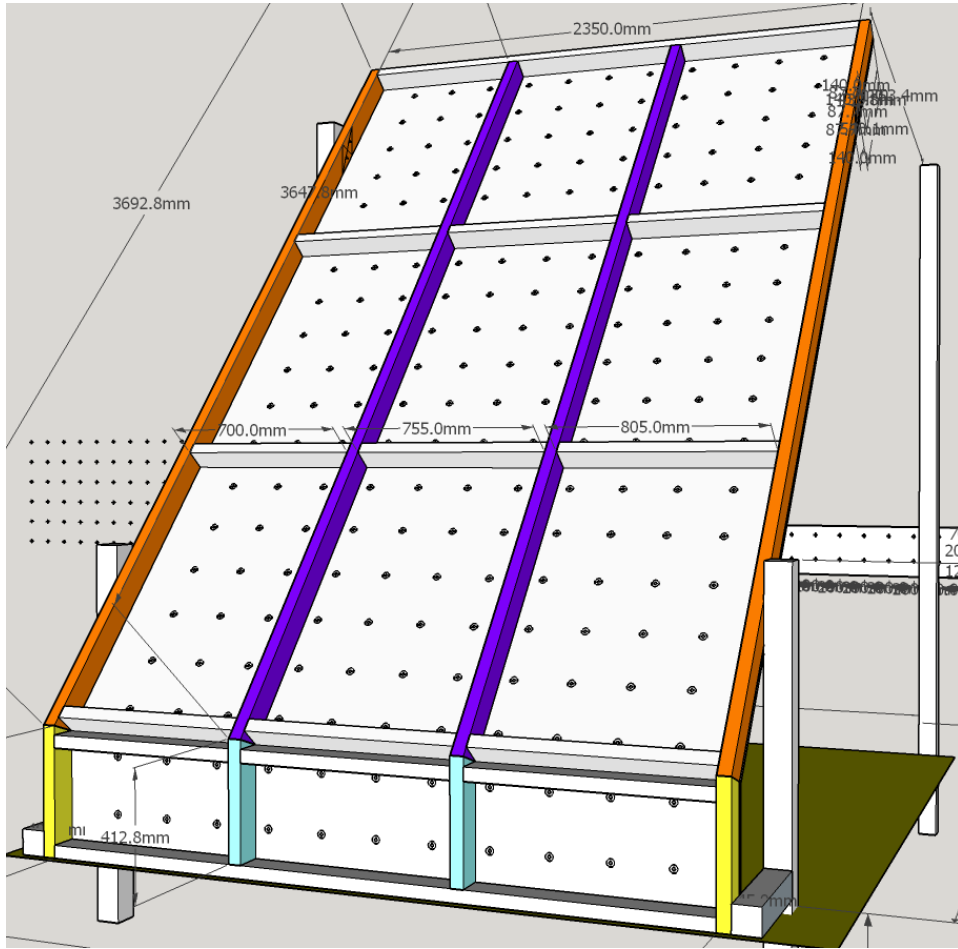

1-car bay climbing wall

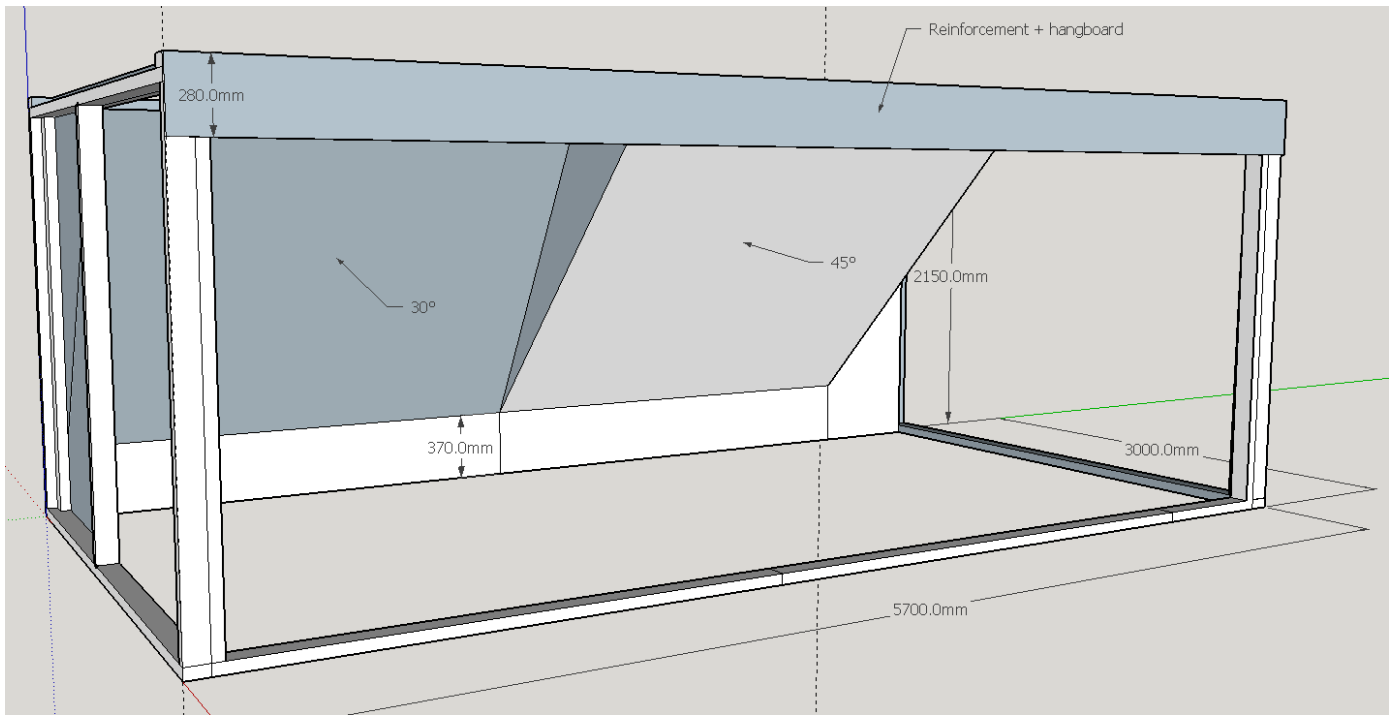

Custom training frames

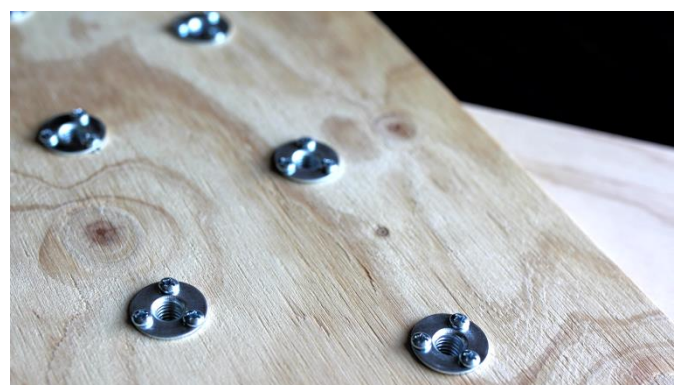
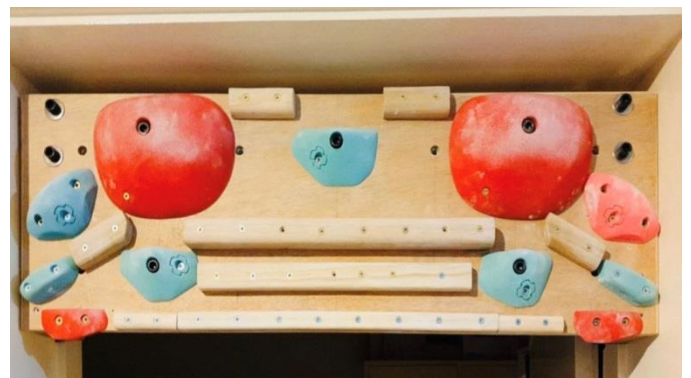
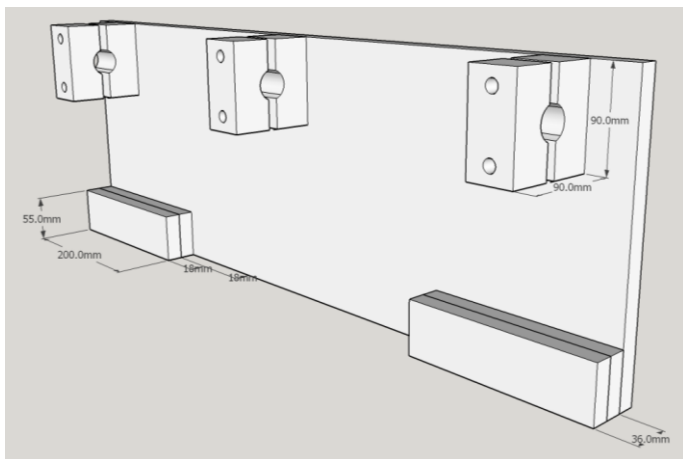
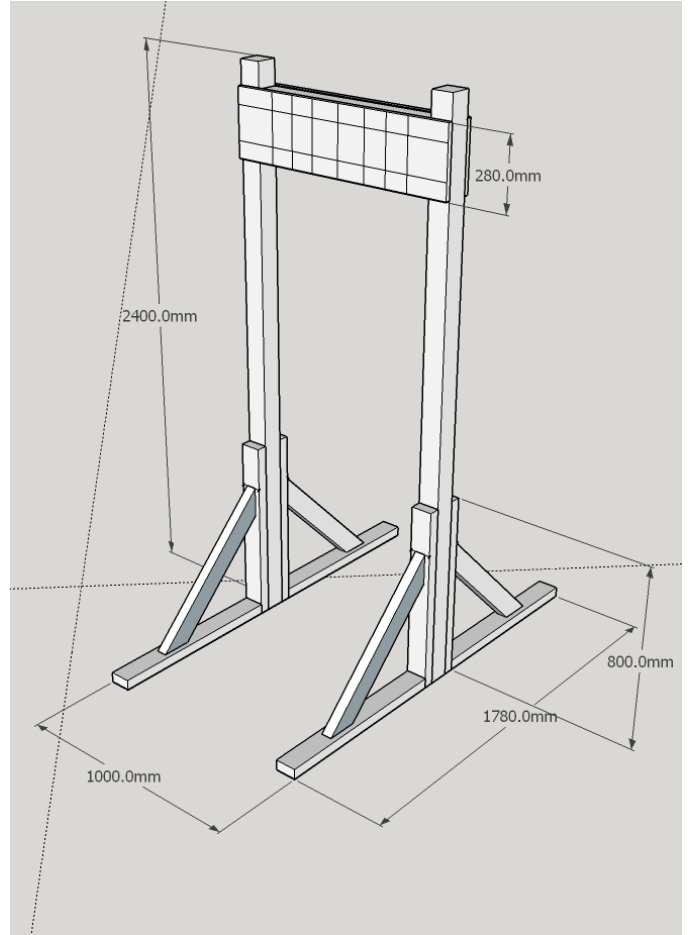

Wall panels

Starting price: \$655

Pre-drilled, t-nutted structural plywood.

Length: 2400mm

Width: 1200mm

Thickness: 19mm

Options:

- varnished or painted,
- textured or not,

Spacing:

- Moonboard 200 x 200,
- Kid friendly: 120 x 150,
- Dense: 100 x 100,
- Custom spacing.



COLOURS

TNUT's effort into standardising and customising colours allows head route setters to extend their range of existing colours and climbers to easily distinguish between colours on the wall.

STANDARD colours:

TNUT Climbing offers a range of eye-catching colours widely used by other hold manufacturers in Europe and the US. We have the formulas to achieve the following distinct and codified RAL and PANTONE colours:

- Jet Black RAL 9005
- Sky Blue RAL 5015
- Signal Blue RAL 5005 (not shown here)
- Orange RAL 2003
- Teal RAL 6027
- Grey RAL 7001
- Yellow RAL 1021
- Yellow Pantone 115C
- Yellow Pantone 116C [OUT OF STOCK]
- Red RAL 3020 (not shown here)
- Violet RAL 4008
- Purple RAL 4005
- Green 16-16 or Pantone 7739C
- Pink Heather Violet RAL 4003 (not shown here)



FLUORO colours

- Fluoro Yellow
- Fluoro Pink
- Fluoro GREEN (Pantone 802C) +15% surcharge
- Fluoro Orange [OUT OF STOCK]
- Fluoro RED (Pantone 805C) [OUT OF STOCK]
- Fluoro BLUE (not shown here)



IN-HOUSE colours:

- TNUT's Green Pantone 3275C (see Geometric series)
- Mustard
- Rust
- Mint
- Sherbet
- Lavender / Lilac





Sebastian Fuller on Kalbarri Gold 26*** Western Australia

BASIC colours:

- Black
- Dark Brown (~RAL 8015)
- Light Brown (~RAL 2013)
- Red (~Pantone 3517C)
- Light Red (~RAL 3028)
- Gold (~RAL 1005)
- Yellow (~RAL 1018)
- Dark Blue
- Light Blue (~Pantone 2185 C)
- Dark Green (~Pantone 2245 C)
- N/A
- Grassy Green (~RAL 6017)
- Natural (~Pantone 7499C)
- Off White (~RAL 1015)



COLOUR MATCHING SERVICE

TNUT Climbing offers a range of eye-catching colours and colours used by other hold manufacturers in Europe and the US. Provided you have few weeks up your sleeves, TNUT Climbing will attempt to match your existing hold colour (minimum order applies).



TECHNICAL INFORMATION:

- Holds are made of resistant polyurethane material.
- Screw holes are meticulously placed to prevent spinning holds.
- The texture is the perfect balance between comfort and friction.
- All holds are engineered with stainless steel washers for longevity.
- Designed and produced by Remi Vignals, experienced rock climber and route setter.



ATTACHMENT SYSTEM

Most of TNUT's BOLT-ON HOLDS have 2 holes:

- The 10mm diameter hole is for fixing the hold into a standard imperial 3/8" t-nut and requires 3/8" (UNC) socket head bolts of varying lengths (from 1" ¼ to 4" ½). M10 t-nuts will require M10 socket head bolts.
- The 3/16" (~5mm) diameter hole prevents the holds from spinning. We recommend using non-self-drilling timber screws of 8G/10G x 30mm to 100mm.

TNUT's SCREW-ON HOLDS have at least two holes of diameter 3/16". We recommend using non-self-drilling timber screws of 10G x 30mm to 60mm.

Wurth ASSY screws are highly recommended to any serious setters and climbing/bouldering centres.

All 10mm holes and 3/16" holes have been reinforced with marine grade stainless steel washers (316).

Bolts and/or screws are not supplied with standard sets of holds. They can be purchased separately.

All prices include GST.

DIRECT PAYMENT DETAILS:

TNUT CLIMBING
BSB: 067-873
Acct: 1378 4522

PayID:

remi@tnut.com.au

CONTACTS:

TNUT CLIMBING
PERTH Western Australia
remi@tnut.au | 0412 963 919
IG: @tnutclimbing

ABN: 69435179093

