

PRODUCT CATALOGUE

2026 - 2027

TURBO
GARDENING MACHINERY

www.turbogardening.com



GREETINGS

FROM TURBO GARDENING MACHINERY

We are a specialized manufacturer dedicated to the research, development, and production of gasoline powered garden machinery, including lawn mowers, tillers, scarifiers, trimmers, and engines, as well as spare parts and accessories. Headquartered in Shangyu, Zhejiang Province, we have established ourselves as a reliable partner in the global garden machinery industry.



TURBO
GARDENING MACHINERY

ZHEJIANG TURBO GARDENING MACHINERY CO., LTD.

✉ dan.li@turbogardening.com

★ www.turbogardening.com

📍 #138 East Jianghuan Rd., The East Industrial Park,
Shangyu, Zhejiang, China, 312300

☎ +86 187 2109 6950

SCAN FOR WECHAT



www.turbogardening.com



**BUILDING
TRUST
THROUGH
QUALITY
& RELIABILITY**

TURBO
GARDENING MACHINERY





Founded in 2015, we have evolved into a trusted strategic partner for leading global brands in the garden machinery industry. Moving beyond the role of a conventional supplier, we are committed to delivering high-value solutions that contribute to our partners' long-term commercial success.

With comprehensive OEM and ODM capabilities, we collaborate closely with our customers from initial concept through to full commercialization. Backed by advanced manufacturing infrastructure and rigorous testing systems, we consistently refine product quality, elevate performance standards, and optimize cost efficiency to meet the expectations of demanding international markets.

All models are tested by global labs & certified.

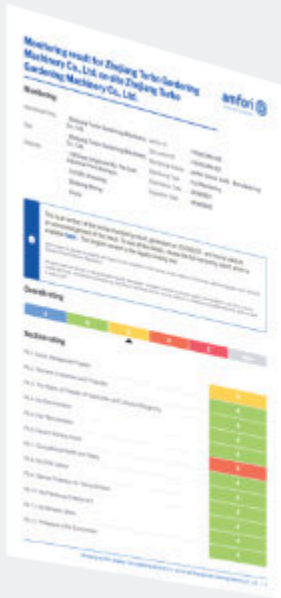

BSCI Report



CE
(gasoline products)



CE
(electric products)



EURO V



ISO 9001



SGS



Noise



EMC

66+ Design, Development & Invention Patents.





**Innovation-Driven
Growth**



**Quality
Guaranteed**



**Timely
Delivery**



**Long-term
Cooperation**



Customer
Oriented



Global Market
Expansion



OEM & ODM
Excellence



Sustainable
Manufacturing



Lawn Mowers, Trimmers & Engines



16" - 22" Gasoline Mowers 14



Zero-Turn Gasoline Mower 44



Foldable Gasoline Mower 47



Cross-Blade System 50



Vertical Shaft Engines 53



Electric Corded Mowers 57



Robotic Mower 61



Self-Propelled Trimmer 63



Tillers, Scarifiers, Spare Parts & Others



Front-Tine Tillers **66**



Horizontal Shaft Engines **70**



Reverse Gear Tiller **72**



Rear-Tine Tiller **75**



Gasoline Scarifier **79**



Spare Parts **82**



Accessories **85**

Turbo Gardening Machinery

**First Product
Launch**



**Production Capacity
Enhancement**



**National High-Tech
Recognition**



2015

2016

2017

2018

2019

2020

2021

**Company
Founded**



**Globalization
Commenced**



**European Market
Coverage**



**Production Line
Improvement**



10+ YEARS
MANUFACTURING

100,000+ UNITS
PER YEAR

20+ PRODUCT
CATEGORIES

50+ COUNTRIES
COVERED

Development Chronicle

Technological Breakthroughs



Product Range Expansion



Global Engagement



Industry Leader



2022

2023

2024

2025

2026

2027

2028

"5000+" Strategy Implementation



R&D Centre Upgrade



Smart Manufacturing



66+ PATENTS REGISTERED

40,000+ M² FACILITY

>10% ANNUAL SALES INVESTED IN R&D

39% AVERAGE ANNUAL GROWTH RATE



16-inch Gasoline Mowers



Easy Handling



Fuel Efficient



Beginner Friendly



Compact Storage

OPTIONAL COVERS



TB40S01A

Turbo Powered

TURBO



25KG
Gross Weight



65×52×42cm
Carton Dimensions



492pcs
MOQ (40HQ)

Engine Model	TB1P65F	Cutting Width	400mm
Engine Power	2.7kW (3.6HP)	Cutting Height	25-75mm
Engine Speed	2800rpm	Height Adjustment	7-level central adjustment
Engine Displacement	139cc	Noise Level	96dB(A)
Starting System	Recoil	Blade	Straight blade
Deck Material	Steel	Wheel (inch)	Front 6, rear 8
Walk Type	Self-propelled	Grass Catcher Capacity	40L, fabric bag
Discharge	Rear		

All models are customizable.

E-start available.



16" Hand-pushed Models



TB40P01A

Turbo Powered



21KG
Gross Weight

65x48x38cm
Carton Dimensions

630pcs
MOQ (40HQ)

Engine Model	TB1P65F	Cutting Width	400mm
Engine Power	2.7kW (3.6HP)	Cutting Height	30-60mm
Engine Speed	2800rpm	Height Adjustment	3 (four wheels adjustment)
Engine Displacement	139cc	Noise Level	96dB(A)
Starting System	Recoil	Blade	Straight blade
Deck Material	Plastic	Wheel (inch)	Front 6, rear 6
Walk Type	Hand push	Grass Catcher Capacity	40L, fabric bag
Discharge	Rear		



TB40P02

B&S Powered



21KG
Gross Weight

65x48x38cm
Carton Dimensions

630pcs
MOQ (40HQ)

Engine Model	BS450E	Cutting Width	400mm
Engine Power	1.8kW (2.4HP)	Cutting Height	30-60mm
Engine Speed	2800rpm	Height Adjustment	3 (four wheels adjustment)
Engine Displacement	125cc	Noise Level	96dB(A)
Starting System	Recoil	Blade	Straight blade
Deck Material	Steel	Wheel (inch)	Front 6, rear 6
Walk Type	Hand push	Grass Catcher Capacity	40L, fabric bag
Discharge	Rear		



TB40P03A

Loncin Powered



21KG
Gross Weight

65x48x38cm
Carton Dimensions

630pcs
MOQ (40HQ)

Engine Model	LC1P65FE-3	Cutting Width	400mm
Engine Power	2.1kW (2.8HP)	Cutting Height	30-60mm
Engine Speed	2800rpm	Height Adjustment	3 (four wheels adjustment)
Engine Displacement	123cc	Noise Level	96dB(A)
Starting System	Recoil	Blade	Straight blade
Deck Material	Steel	Wheel (inch)	Front 6, rear 6
Walk Type	Hand push	Grass Catcher Capacity	40L, fabric bag
Discharge	Rear		



TB40P04

RATO Powered



21KG
Gross Weight

65x48x38cm
Carton Dimensions

630pcs
MOQ (40HQ)

Engine Model	RV125-S	Cutting Width	400mm
Engine Power	2.0kW (2.7HP)	Cutting Height	30-60mm
Engine Speed	2800rpm	Height Adjustment	3 (four wheels adjustment)
Engine Displacement	127cc	Noise Level	96dB(A)
Starting System	Recoil	Blade	Straight blade
Deck Material	Steel	Wheel (inch)	Front 6, rear 6
Walk Type	Hand push	Grass Catcher Capacity	40L, fabric bag
Discharge	Rear		

16" Self-propelled Models



TB40S01A

Turbo Powered



25KG
Gross Weight



65x52x42cm
Carton Dimensions



492pcs
MOQ (40HQ)

Engine Model	TB1P65F	Cutting Width	400mm
Engine Power	2.7kW (3.6HP)	Cutting Height	25-75mm
Engine Speed	2800rpm	Height Adjustment	7-level central adjustment
Engine Displacement	139cc	Noise Level	96dB(A)
Starting System	Recoil	Blade	Straight blade
Deck Material	Steel	Wheel (inch)	Front 6, rear 8
Walk Type	Self-propelled	Grass Catcher Capacity	40L, fabric bag
Discharge	Rear		



TB40S02

B&S Powered



25KG
Gross Weight



65x52x42cm
Carton Dimensions



492pcs
MOQ (40HQ)

Engine Model	BS450E	Cutting Width	400mm
Engine Power	1.8kW (2.4HP)	Cutting Height	25-75mm
Engine Speed	2800rpm	Height Adjustment	7-level central adjustment
Engine Displacement	125cc	Noise Level	96dB (A)
Starting System	Recoil	Blade	Straight blade
Deck Material	Steel	Wheel (inch)	Front 6, rear 8
Walk Type	Self-propelled	Grass Catcher Capacity	40L, fabric bag
Discharge	Rear		



TB40S03

Loncin Powered



25KG
Gross Weight



65x52x42cm
Carton Dimensions



492pcs
MOQ (40HQ)

Engine Model	LC1P65FE	Cutting Width	400mm
Engine Power	2.4kW (3.2HP)	Cutting Height	25-75mm
Engine Speed	2800rpm	Height Adjustment	7-level central adjustment
Engine Displacement	139cc	Noise Level	96dB (A)
Starting System	Recoil	Blade	Straight blade
Deck Material	Steel	Wheel (inch)	Front 6, rear 8
Walk Type	Self-propelled	Grass Catcher Capacity	40L, fabric bag
Discharge	Rear		



TB40S04

RATO Powered



25KG
Gross Weight



65x52x42cm
Carton Dimensions



492pcs
MOQ (40HQ)

Engine Model	RV125-S	Cutting Width	400mm
Engine Power	2.0kW (2.7HP)	Cutting Height	25-75mm
Engine Speed	2800rpm	Height Adjustment	7-level central adjustment
Engine Displacement	127cc	Noise Level	96dB (A)
Starting System	Recoil	Blade	Straight blade
Deck Material	Steel	Wheel (inch)	Front 6, rear 8
Walk Type	Self-propelled	Grass Catcher Capacity	40L, fabric bag
Discharge	Rear		





17-inch Gasoline Mowers



Reliable Cutting



Low Maintenance



Easy Controls



Balanced Performance

OPTIONAL COVERS



A



B



C



D



E



TB43S01A

Turbo Powered

TURBO



26KG
Gross Weight



69x52x44cm
Carton Dimensions



370pcs
MOQ (40HQ)

Engine Model	TB1P65F	Cutting Width	430mm
Engine Power	2.7kW (3.6HP)	Cutting Height	25-75mm
Engine Speed	2800rpm	Height Adjustment	6-level central adjustment
Engine Displacement	139cc	Noise Level	96dB (A)
Starting System	Recoil	Blade	Straight blade
Deck Material	Steel	Wheel (inch)	Front 6, rear 8
Walk Type	Self-propelled	Grass Catcher Capacity	40L, half plastic bag
Discharge	Rear		

All models are customizable.

E-start available.



17" Hand-pushed Models



TB43P01A

Turbo Powered



26KG
Gross Weight

69x52x44cm
Carton Dimensions

444pcs
MOQ (40HQ)

Engine Model	TB1P65F	Cutting Width	430mm
Engine Power	2.7kW (3.6HP)	Cutting Height	25-75mm
Engine Speed	2800rpm	Height Adjustment	6-level central adjustment
Engine Displacement	139cc	Noise Level	96dB (A)
Starting System	Recoil	Blade	Straight blade
Deck Material	Steel	Wheel (inch)	Front 6, rear 8
Walk Type	Hand push	Grass Catcher Capacity	40L, half plastic bag
Discharge	Rear		



TB43P02

B&S Powered



26KG
Gross Weight

69x52x42cm
Carton Dimensions

444pcs
MOQ (40HQ)

Engine Model	BS450E	Cutting Width	430mm
Engine Power	1.8kW (2.4HP)	Cutting Height	25-75mm
Engine Speed	2800rpm	Height Adjustment	6-level central adjustment
Engine Displacement	125cc	Noise Level	96dB (A)
Starting System	Recoil	Blade	Straight blade
Deck Material	Steel	Wheel (inch)	Front 6, rear 8
Walk Type	Hand push	Grass Catcher Capacity	40L, fabric bag
Discharge	Rear		



TB43P03

Loncin Powered



26KG
Gross Weight

69x52x42cm
Carton Dimensions

444pcs
MOQ (40HQ)

Engine Model	LC1P65FE	Cutting Width	430mm
Engine Power	2.4kW (3.2HP)	Cutting Height	25-75mm
Engine Speed	2800rpm	Height Adjustment	6-level central adjustment
Engine Displacement	139cc	Noise Level	96dB (A)
Starting System	Recoil	Blade	Straight blade
Deck Material	Steel	Wheel (inch)	Front 6, rear 8
Walk Type	Hand push	Grass Catcher Capacity	40L, fabric bag
Discharge	Rear		



TB43P04

RATO Powered



26KG
Gross Weight

65x48x38cm
Carton Dimensions

444pcs
MOQ (40HQ)

Engine Model	RV125-S	Cutting Width	430mm
Engine Power	2.0kW (2.7HP)	Cutting Height	25-75mm
Engine Speed	2800rpm	Height Adjustment	6-level central adjustment
Engine Displacement	127cc	Noise Level	96dB (A)
Starting System	Recoil	Blade	Straight blade
Deck Material	Steel	Wheel (inch)	Front 6, rear 8
Walk Type	Hand push	Grass Catcher Capacity	40L, fabric bag
Discharge	Rear		

17" Self-propelled Models



TB43S01A

Turbo Powered



26KG
Gross Weight



69x52x44cm
Carton Dimensions



444pcs
MOQ (40HQ)

Engine Model	TB1P65F	Cutting Width	430mm
Engine Power	2.7kW (3.6HP)	Cutting Height	25-75mm
Engine Speed	2800rpm	Height Adjustment	6-level central adjustment
Engine Displacement	139cc	Noise Level	96dB (A)
Starting System	Recoil	Blade	Straight blade
Deck Material	Steel	Wheel (inch)	Front 6, rear 8
Walk Type	Self-propelled	Grass Catcher Capacity	40L, fabric bag
Discharge	Rear		



TB43S02

B&S Powered



26KG
Gross Weight



65x52x42cm
Carton Dimensions



444pcs
MOQ (40HQ)

Engine Model	BS450E	Cutting Width	430mm
Engine Power	1.8kW (2.4HP)	Cutting Height	25-75mm
Engine Speed	2800rpm	Height Adjustment	6-level central adjustment
Engine Displacement	125cc	Noise Level	96dB (A)
Starting System	Recoil	Blade	Straight blade
Deck Material	Steel	Wheel (inch)	Front 6, rear 8
Walk Type	Self-propelled	Grass Catcher Capacity	40L, fabric bag
Discharge	Rear		



TB43S03

Loncin Powered



26KG
Gross Weight



69x52x44cm
Carton Dimensions



444pcs
MOQ (40HQ)

Engine Model	LC1P65FE	Cutting Width	430mm
Engine Power	2.4kW (3.2HP)	Cutting Height	25-75mm
Engine Speed	2800rpm	Height Adjustment	6-level central adjustment
Engine Displacement	139cc	Noise Level	96dB (A)
Starting System	Recoil	Blade	Straight blade
Deck Material	Steel	Wheel (inch)	Front 6, rear 8
Walk Type	Self-propelled	Grass Catcher Capacity	40L, fabric bag
Discharge	Rear		



TB43S04

RATO Powered



26KG
Gross Weight



65x52x42cm
Carton Dimensions



444pcs
MOQ (40HQ)

Engine Model	RV125-S	Cutting Width	430mm
Engine Power	2.0kW (2.7HP)	Cutting Height	25-75mm
Engine Speed	2800rpm	Height Adjustment	6-level central adjustment
Engine Displacement	127cc	Noise Level	96dB (A)
Starting System	Recoil	Blade	Straight blade
Deck Material	Steel	Wheel (inch)	Front 6, rear 8
Walk Type	Self-propelled	Grass Catcher Capacity	40L, fabric bag
Discharge	Rear		



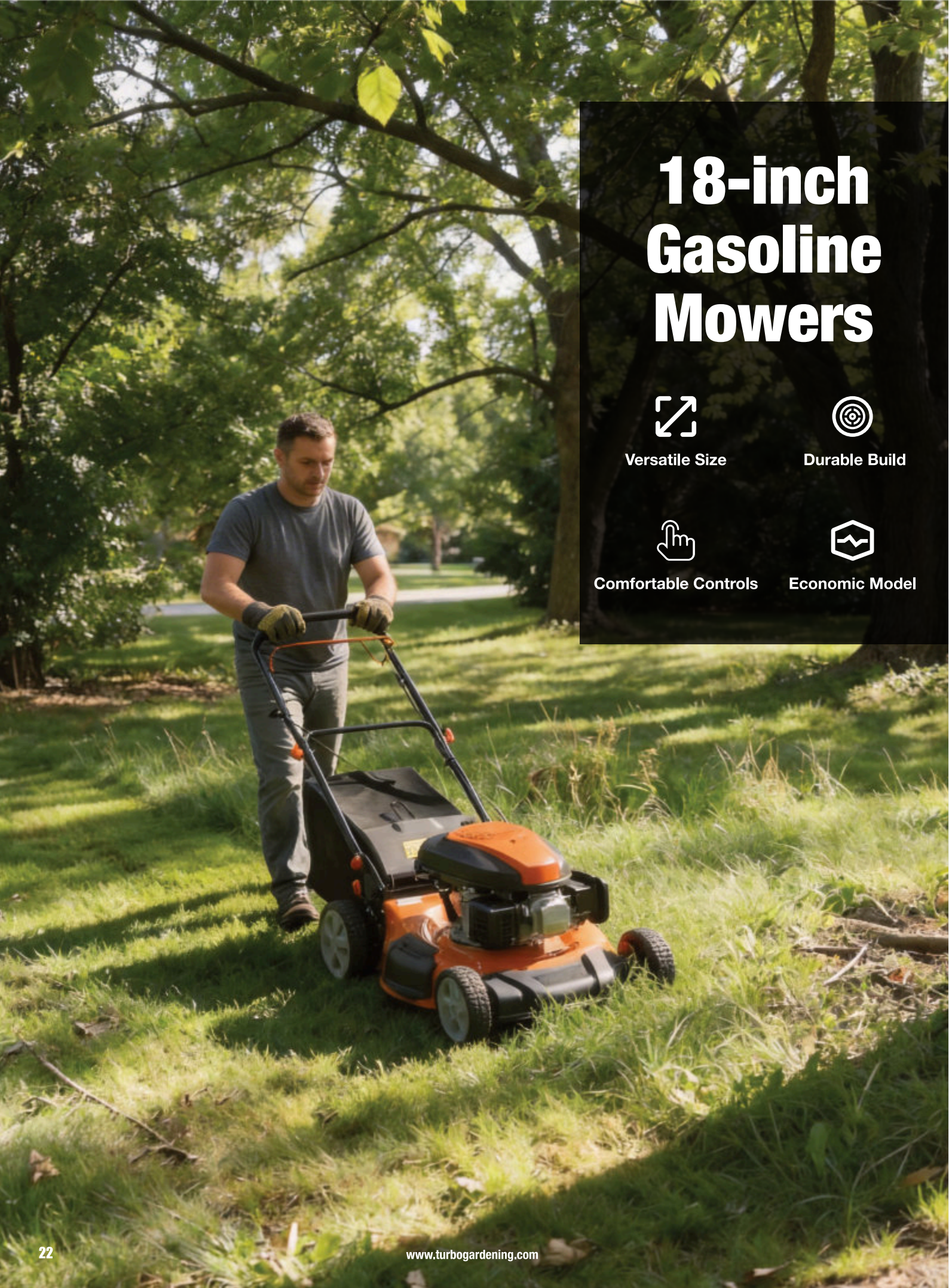

18-inch Gasoline Mowers



Versatile Size



Durable Build



Comfortable Controls



Economic Model

OPTIONAL COVERS



A



B



C



D



E



TB46S11E

Turbo Powered



35KG
Gross Weight



79x57x49cm
Carton Dimensions



300pcs
MOQ (40HQ)

Engine Model	TB1P65F	Cutting Width	460mm
Engine Power	2.7kW (3.6HP)	Cutting Height	25-75mm
Engine Speed	2800rpm	Height Adjustment	7-level central adjustment
Engine Displacement	139cc	Noise Level	96dB (A)
Starting System	Recoil & electric start	Blade	Straight blade
Deck Material	Steel	Wheel (inch)	Front 7, rear 10
Walk Type	Self-propelled	Grass Catcher Capacity	60L, half plastic bag
Discharge	Rear, side discharge, mulching	Features	1. Foamed upper handle 2. Front handle 3. Washing hole

All models are customizable.

E-start available.



18" Hand-pushed Models



TB46P01

Turbo Powered



35KG
Gross Weight

76x57x44cm
Carton Dimensions

377pcs
MOQ (40HQ)

Engine Model	TB1P65F	Cutting Width	460mm
Engine Power	2.7kW (3.6HP)	Cutting Height	25-75mm
Engine Speed	2800rpm	Height Adjustment	7-level central adjustment
Engine Displacement	139cc	Noise Level	96dB (A)
Starting System	Recoil	Blade	Straight blade
Deck Material	Steel	Wheel (inch)	Front 6, rear 8
Walk Type	Hand push	Grass Catcher Capacity	60L, fabric bag
Discharge	Rear		



TB46P02

B&S Powered



35KG
Gross Weight

76x57x44cm
Carton Dimensions

377pcs
MOQ (40HQ)

Engine Model	BS500E	Cutting Width	460mm
Engine Power	2.1kW (2.8HP)	Cutting Height	25-75mm
Engine Speed	2800rpm	Height Adjustment	7-level central adjustment
Engine Displacement	140cc	Noise Level	96dB (A)
Starting System	Recoil	Blade	Straight blade
Deck Material	Steel	Wheel (inch)	Front 6, rear 8
Walk Type	Hand push	Grass Catcher Capacity	60L, fabric bag
Discharge	Rear		



TB46P03

Loncin Powered



35KG
Gross Weight

76x57x48cm
Carton Dimensions

377pcs
MOQ (40HQ)

Engine Model	LC1P65FE	Cutting Width	460mm
Engine Power	2.4kW (3.2HP)	Cutting Height	25-75mm
Engine Speed	2800rpm	Height Adjustment	7-level central adjustment
Engine Displacement	139cc	Noise Level	96dB (A)
Starting System	Recoil	Blade	Straight blade
Deck Material	Steel	Wheel (inch)	Front 6, rear 8
Walk Type	Hand push	Grass Catcher Capacity	60L, half plastic bag
Discharge	Rear		



TB46P04

RATO Powered



35KG
Gross Weight

76x57x48cm
Carton Dimensions

377pcs
MOQ (40HQ)

Engine Model	RV125-S	Cutting Width	460mm
Engine Power	2.0kW (2.7HP)	Cutting Height	25-75mm
Engine Speed	2800rpm	Height Adjustment	7-level central adjustment
Engine Displacement	127cc	Noise Level	96dB (A)
Starting System	Recoil	Blade	Straight blade
Deck Material	Steel	Wheel (inch)	Front 6, rear 8
Walk Type	Hand push	Grass Catcher Capacity	60L, half plastic bag
Discharge	Rear		

18" Self-propelled Models



TB46S11

Turbo Powered



35KG
Gross Weight



79x57x49cm
Carton Dimensions



300pcs
MOQ (40HQ)

Engine Model	TB1P65F	Cutting Width	460mm
Engine Power	2.7kW (3.6HP)	Cutting Height	25-75mm
Engine Speed	2800rpm	Height Adjustment	7-level central adjustment
Engine Displacement	139cc	Noise Level	96dB (A)
Starting System	Recoil	Blade	Straight blade
Deck Material	Steel	Wheel (inch)	Front 7, rear 10
Walk Type	Self-propelled	Grass Catcher Capacity	60L, half plastic bag
Discharge	Rear, side discharge, mulching	Features	1. Foamed upper handle 2. Front handle 3. Control panel 4. Washing hole



TB46S12

B&S Powered



35KG
Gross Weight



79x57x49cm
Carton Dimensions



300pcs
MOQ (40HQ)

Engine Model	BS500E	Cutting Width	460mm
Engine Power	2.1kW (2.8HP)	Cutting Height	25-75mm
Engine Speed	2800rpm	Height Adjustment	7-level central adjustment
Engine Displacement	140cc	Noise Level	96dB (A)
Starting System	Recoil	Blade	Straight blade
Deck Material	Steel	Wheel (inch)	Front 7, rear 10
Walk Type	Self-propelled	Grass Catcher Capacity	60L, half plastic bag
Discharge	Rear, side discharge, mulching	Features	1. Foamed upper handle 2. Front handle 3. Control panel 4. Washing hole



TB46S13A

Loncin Powered



35KG
Gross Weight



79x57x49cm
Carton Dimensions



300pcs
MOQ (40HQ)

Engine Model	LC1P65FC	Cutting Width	460mm
Engine Power	2.7kW (3.6HP)	Cutting Height	25-75mm
Engine Speed	2800rpm	Height Adjustment	7-level central adjustment
Engine Displacement	159cc	Noise Level	96dB (A)
Starting System	Recoil	Blade	Straight blade
Deck Material	Steel	Wheel (inch)	Front 7, rear 10
Walk Type	Self-propelled	Grass Catcher Capacity	60L, half plastic bag
Discharge	Rear, side discharge, mulching	Features	1. Foamed upper handle 2. Front handle 3. Control panel 4. Washing hole



TB46S14

RATO Powered



35KG
Gross Weight



79x57x49cm
Carton Dimensions



300pcs
MOQ (40HQ)

Engine Model	RV125-S	Cutting Width	460mm
Engine Power	2.0kW (2.7HP)	Cutting Height	25-75mm
Engine Speed	2800rpm	Height Adjustment	7-level central adjustment
Engine Displacement	127cc	Noise Level	96dB (A)
Starting System	Recoil	Blade	Straight blade
Deck Material	Steel	Wheel (inch)	Front 7, rear 10
Walk Type	Self-propelled	Grass Catcher Capacity	60L, half plastic bag
Discharge	Rear, side discharge, mulching	Features	1. Foamed upper handle 2. Front handle 3. Control panel 4. Washing hole



20-inch Gasoline Mowers



Efficient Cutting



Rugged Build



Wide Deck



Powerful Engine



Suitable for Medium-Size Lawns



Reliable Performance



OPTIONAL COVERS



A



B



C



D



E



TB51S11E

Turbo Powered



40KG
Gross Weight



83x57x49cm
Carton Dimensions



285pcs
MOQ (40HQ)

Engine Model	TB1P70FA	Cutting Width	510mm
Engine Power	3.6kW (4.8HP)	Cutting Height	25-75mm
Engine Speed	2800rpm	Height Adjustment	7-level central adjustment
Engine Displacement	173cc	Noise Level	98dB (A)
Starting System	Recoil & electric start	Blade	Straight blade
Deck Material	Steel	Wheel (inch)	Front 8, rear 10
Walk Type	Self-propelled	Grass Catcher Capacity	60L, half plastic bag
Discharge	Rear, side discharge, mulching	Features	1. Foamed upper handle 2. Front handle 3. Washing hole

All models are customizable.

E-start available.



20" Models



TB51P01

Turbo Powered



40KG
Gross Weight

83x57x49cm
Carton Dimensions

285pcs
MOQ (40HQ)

Engine Model	TB1P70FA	Cutting Width	510mm
Engine Power	3.6kW (4.8HP)	Cutting Height	25-75mm
Engine Speed	2800rpm	Height Adjustment	7-level central adjustment
Engine Displacement	173cc	Noise Level	98dB (A)
Starting System	Recoil	Blade	Straight blade
Deck Material	Steel	Wheel (inch)	Front 8, rear 10
Walk Type	Hand push	Grass Catcher Capacity	60L, half plastic bag
Discharge	Rear, side discharge, mulching	Features	1. Foamed upper handle 2. Front handle 3. Control panel 4. Washing hole



TB51P03

Loncin Powered



40KG
Gross Weight

83x57x49cm
Carton Dimensions

285pcs
MOQ (40HQ)

Engine Model	LC1P70FC	Cutting Width	510mm
Engine Power	3.5kW (4.8HP)	Cutting Height	25-75mm
Engine Speed	2800rpm	Height Adjustment	7-level central adjustment
Engine Displacement	196cc	Noise Level	98dB (A)
Starting System	Recoil & electric start	Blade	Straight blade
Deck Material	Steel	Wheel (inch)	Front 8, rear 10
Walk Type	Hand push	Grass Catcher Capacity	60L, half plastic bag
Discharge	Rear, side discharge, mulching	Features	1. Foamed upper handle 2. Front handle 3. Control panel 4. Washing hole



TB51S01

Turbo Powered



40KG
Gross Weight

83x57x49cm
Carton Dimensions

285pcs
MOQ (40HQ)

Engine Model	TB1P70FA	Cutting Width	510mm
Engine Power	3.6kW (4.8HP)	Cutting Height	25-75mm
Engine Speed	2800rpm	Height Adjustment	7-level central adjustment
Engine Displacement	173cc	Noise Level	98dB (A)
Starting System	Recoil	Blade	Straight blade
Deck Material	Steel	Wheel (inch)	Front 8, rear 10
Walk Type	Self-propelled	Grass Catcher Capacity	60L, half plastic bag
Discharge	Rear, mulching	Features	1. Foamed upper handle 2. Front handle 3. Control panel 4. Washing hole



TB51S03

Loncin Powered



40KG
Gross Weight

83x57x49cm
Carton Dimensions

285pcs
MOQ (40HQ)

Engine Model	LC1P70FC	Cutting Width	510mm
Engine Power	3.5kW (4.8HP)	Cutting Height	25-75mm
Engine Speed	2800rpm	Height Adjustment	7-level central adjustment
Engine Displacement	196cc	Noise Level	98dB (A)
Starting System	Recoil & electric start	Blade	Straight blade
Deck Material	Steel	Wheel (inch)	Front 8, rear 10
Walk Type	Self-propelled	Grass Catcher Capacity	60L, half plastic bag
Discharge	Rear, mulching	Features	1. Foamed upper handle 2. Front handle 3. Control panel 4. Washing hole



TB51S11

Turbo Powered



40KG
Gross Weight



83x57x49cm
Carton Dimensions



285pcs
MOQ (40HQ)

Engine Model	TB1P70FA	Cutting Width	510mm
Engine Power	3.6kW (4.8HP)	Cutting Height	25-75mm
Engine Speed	2800rpm	Height Adjustment	7-level central adjustment
Engine Displacement	173cc	Noise Level	98dB (A)
Starting System	Recoil	Blade	Straight blade
Deck Material	Steel	Wheel (inch)	Front 8, rear 10
Walk Type	Self-propelled	Grass Catcher Capacity	60L, half plastic bag
Discharge	Rear, side discharge, mulching	Features	1. Foamed upper handle 2. Front handle 3. Control panel 4. Washing hole



TB51S11E

Turbo Powered



40KG
Gross Weight



83x57x49cm
Carton Dimensions



285pcs
MOQ (40HQ)

Engine Model	TB1P70FA	Cutting Width	510mm
Engine Power	3.6kW (4.8HP)	Cutting Height	25-75mm
Engine Speed	2800rpm	Height Adjustment	7-level central adjustment
Engine Displacement	173cc	Noise Level	98dB (A)
Starting System	Recoil & electric start	Blade	Straight blade
Deck Material	Steel	Wheel (inch)	Front 8, rear 10
Walk Type	Self-propelled	Grass Catcher Capacity	60L, half plastic bag
Discharge	Rear, side discharge, mulching	Features	1. Foamed upper handle 2. Front handle 3. Control panel 4. Washing hole



TB51S13A

Loncin Powered



40KG
Gross Weight



83x57x49cm
Carton Dimensions



285pcs
MOQ (40HQ)

Engine Model	LC1P70FC	Cutting Width	510mm
Engine Power	3.5kW (4.8HP)	Cutting Height	25-75mm
Engine Speed	2800rpm	Height Adjustment	7-level central adjustment
Engine Displacement	196cc	Noise Level	98dB (A)
Starting System	Recoil	Blade	Straight blade
Deck Material	Steel	Wheel (inch)	Front 8, rear 10
Walk Type	Self-propelled	Grass Catcher Capacity	60L, half plastic bag
Discharge	Rear, side discharge, mulching	Features	1. Foamed upper handle 2. Front handle 3. Control panel 4. Washing hole



TB51S13AE

Loncin Powered



40KG
Gross Weight



83x57x49cm
Carton Dimensions



285pcs
MOQ (40HQ)

Engine Model	LC1P70FC	Cutting Width	510mm
Engine Power	3.5kW (4.8HP)	Cutting Height	25-75mm
Engine Speed	2800rpm	Height Adjustment	7-level central adjustment
Engine Displacement	196cc	Noise Level	98dB (A)
Starting System	Recoil & electric start	Blade	Straight blade
Deck Material	Steel	Wheel (inch)	Front 8, rear 10
Walk Type	Self-propelled	Grass Catcher Capacity	60L, half plastic bag
Discharge	Rear, side discharge, mulching	Features	1. Foamed upper handle 2. Front handle 3. Control panel 4. Washing hole





21-inch Gasoline Mowers



Professional Cutting



Heavy-Duty Build



High Efficiency



Highly Powerful



Premium Durability



Premium Performance

OPTIONAL COVERS



TB53S11E

Turbo Powered

TURBO



42KG
Gross Weight



86x57x49cm
Carton Dimensions



270pcs
MOQ (40HQ)

Engine Model	TB1P70FA	Cutting Width	530mm
Engine Power	3.6kW (4.8HP)	Cutting Height	25-75mm
Engine Speed	2800rpm	Height Adjustment	7-level central adjustment
Engine Displacement	173cc	Noise Level	98dB (A)
Starting System	Recoil & electric start	Blade	Straight blade
Deck Material	Steel	Wheel (inch)	Front 8, rear 10
Walk Type	Self-propelled	Grass Catcher Capacity	60L, half plastic bag
Discharge	Rear, side discharge, mulching	Features	1. Foamed upper handle 2. Front handle 3. Control panel 4. Washing hole

All models are customizable.

E-start available.



21" Self-propelled Models



TB53S11

Turbo Powered



42KG
Gross Weight

86x57x49cm
Carton Dimensions

270pcs
MOQ (40HQ)

Engine Model	TB1P70FA	Cutting Width	530mm
Engine Power	3.6kW (4.8HP)	Cutting Height	25-75mm
Engine Speed	2800rpm	Height Adjustment	7-level central adjustment
Engine Displacement	173cc	Noise Level	98dB (A)
Starting System	Recoil	Blade	Straight blade
Deck Material	Steel	Wheel (inch)	Front 8, rear 10
Walk Type	Self-propelled	Grass Catcher Capacity	60L, half plastic bag
Discharge	Rear, side discharge, mulching	Features	1. Foamed upper handle 2. Front handle 3. Control panel 4. Washing hole



TB53S11B

Turbo Powered



42KG
Gross Weight

86x57x49cm
Carton Dimensions

270pcs
MOQ (40HQ)

Engine Model	TB1P70FB	Cutting Width	530mm
Engine Power	4.0kW (5.4HP)	Cutting Height	25-75mm
Engine Speed	2800rpm	Height Adjustment	7-level central adjustment
Engine Displacement	196cc	Noise Level	98dB (A)
Starting System	Recoil	Blade	Straight blade
Deck Material	Steel	Wheel (inch)	Front 8, rear 10
Walk Type	Self-propelled	Grass Catcher Capacity	60L, half plastic bag
Discharge	Rear, side discharge, mulching	Features	1. Foamed upper handle 2. Front handle 3. Control panel 4. Washing hole



TB53S13

Loncin Powered



42KG
Gross Weight

86x57x49cm
Carton Dimensions

270pcs
MOQ (40HQ)

Engine Model	LC1P70FC	Cutting Width	530mm
Engine Power	3.5kW (4.8HP)	Cutting Height	25-75mm
Engine Speed	2800rpm	Height Adjustment	7-level central adjustment
Engine Displacement	196cc	Noise Level	98dB (A)
Starting System	Recoil	Blade	Straight blade
Deck Material	Steel	Wheel (inch)	Front 8, rear 10
Walk Type	Self-propelled	Grass Catcher Capacity	60L, half plastic bag
Discharge	Rear, side discharge, mulching	Features	1. Foamed upper handle 2. Front handle 3. Control panel 4. Washing hole



TB53S13B

Loncin Powered



42KG
Gross Weight

86x57x49cm
Carton Dimensions

270pcs
MOQ (40HQ)

Engine Model	V200	Cutting Width	530mm
Engine Power	4.0kW (5.4HP)	Cutting Height	25-75mm
Engine Speed	2800rpm	Height Adjustment	7-level central adjustment
Engine Displacement	196cc	Noise Level	98dB (A)
Starting System	Recoil	Blade	Straight blade
Deck Material	Steel	Wheel (inch)	Front 8, rear 10
Walk Type	Self-propelled	Grass Catcher Capacity	60L, half plastic bag
Discharge	Rear, side discharge, mulching	Features	1. Foamed upper handle 2. Front handle 3. Control panel 4. Washing hole

21" Self-propelled Models



TB53S11E

Turbo Powered



42KG
Gross Weight



86x57x49cm
Carton Dimensions



270pcs
MOQ (40HQ)

Engine Model	TB1P70FA	Cutting Width	530mm
Engine Power	3.6kW (4.8HP)	Cutting Height	25-75mm
Engine Speed	2800rpm	Height Adjustment	7-level central adjustment
Engine Displacement	173cc	Noise Level	98dB (A)
Starting System	Recoil & electric start	Blade	Straight blade
Deck Material	Steel	Wheel (inch)	Front 8, rear 10
Walk Type	Self-propelled	Grass Catcher Capacity	60L, half plastic bag
Discharge	Rear, side discharge, mulching	Features	1. Foamed upper handle 2. Front handle 3. Control panel 4. Washing hole



TB53S11B

Turbo Powered



42KG
Gross Weight



86x57x49cm
Carton Dimensions



270pcs
MOQ (40HQ)

Engine Model	TB1P70FB	Cutting Width	530mm
Engine Power	4.0kW (5.4HP)	Cutting Height	25-75mm
Engine Speed	2800rpm	Height Adjustment	7-level central adjustment
Engine Displacement	196cc	Noise Level	98dB (A)
Starting System	Recoil & electric start	Blade	Straight blade
Deck Material	Steel	Wheel (inch)	Front 8, rear 10
Walk Type	Self-propelled	Grass Catcher Capacity	60L, half plastic bag
Discharge	Rear, side discharge, mulching	Features	1. Foamed upper handle 2. Front handle 3. Control panel 4. Washing hole



TB53S13E

Loncin Powered



42KG
Gross Weight



86x57x49cm
Carton Dimensions



270pcs
MOQ (40HQ)

Engine Model	LC1P70FC	Cutting Width	530mm
Engine Power	3.5kW (4.8HP)	Cutting Height	25-75mm
Engine Speed	2800rpm	Height Adjustment	7-level central adjustment
Engine Displacement	196cc	Noise Level	98dB (A)
Starting System	Recoil & electric start	Blade	Straight blade
Deck Material	Steel	Wheel (inch)	Front 8, rear 10
Walk Type	Self-propelled	Grass Catcher Capacity	60L, half plastic bag
Discharge	Rear, side discharge, mulching	Features	1. Foamed upper handle 2. Front handle 3. Control panel 4. Washing hole



TB53S13BE

Loncin Powered



42KG
Gross Weight



86x57x49cm
Carton Dimensions



270pcs
MOQ (40HQ)

Engine Model	V200	Cutting Width	530mm
Engine Power	4.0kW (5.4HP)	Cutting Height	25-75mm
Engine Speed	2800rpm	Height Adjustment	7-level central adjustment
Engine Displacement	196cc	Noise Level	98dB (A)
Starting System	Recoil & electric start	Blade	Straight blade
Deck Material	Steel	Wheel (inch)	Front 8, rear 10
Walk Type	Self-propelled	Grass Catcher Capacity	60L, half plastic bag
Discharge	Rear, side discharge, mulching	Features	1. Foamed upper handle 2. Front handle 3. Control panel 4. Washing hole





22-inch Gasoline Mowers



Max Cutting Capacity



Robust Build



High Productivity



Long-Lasting Power



Large-lawn Specialist



Flagship Performance

OPTIONAL COVERS



A



B



C



D



E



TB56S11E

Turbo Powered



44KG
Gross Weight



91x61x49cm
Carton Dimensions



225pcs
MOQ (40HQ)

Engine Model	TB1P70FA	Cutting Width	560mm
Engine Power	3.6kW (4.8HP)	Cutting Height	25-75mm
Engine Speed	2800rpm	Height Adjustment	8-level central adjustment
Engine Displacement	173cc	Noise Level	98dB (A)
Starting System	Recoil & electric start	Blade	Straight blade
Deck Material	Steel	Wheel (inch)	Front 8, rear 10
Walk Type	Self-propelled	Grass Catcher Capacity	60L, half plastic bag
Discharge	Rear, side discharge, mulching	Features	1. Foamed upper handle 2. Front handle 3. Control panel 4. Washing hole

All models are customizable.

E-start available.



22" Self-propelled Models



TB56S11

Turbo Powered



44KG
Gross Weight

91x61x49cm
Carton Dimensions

225pcs
MOQ (40HQ)

Engine Model	TB1P70FA	Cutting Width	560mm
Engine Power	3.6kW (4.8HP)	Cutting Height	25-75mm
Engine Speed	2800rpm	Height Adjustment	8-level central adjustment
Engine Displacement	173cc	Noise Level	98dB (A)
Starting System	Recoil	Blade	Straight blade
Deck Material	Steel	Wheel (inch)	Front 8, rear 10
Walk Type	Self-propelled	Grass Catcher Capacity	60L, half plastic bag
Discharge	Rear, side discharge, mulching	Features	1. Foamed upper handle 2. Front handle 3. Control panel 4. Washing hole



TB56S11A

Turbo Powered



44KG
Gross Weight

91x61x49cm
Carton Dimensions

225pcs
MOQ (40HQ)

Engine Model	TB1P70FB	Cutting Width	560mm
Engine Power	4.0kW (5.4HP)	Cutting Height	25-75mm
Engine Speed	2800rpm	Height Adjustment	8-level central adjustment
Engine Displacement	196cc	Noise Level	98dB (A)
Starting System	Recoil	Blade	Straight blade
Deck Material	Steel	Wheel (inch)	Front 8, rear 10
Walk Type	Self-propelled	Grass Catcher Capacity	60L, half plastic bag
Discharge	Rear, side discharge, mulching	Features	1. Foamed upper handle 2. Front handle 3. Control panel 4. Washing hole



TB56S13

Loncin Powered



44KG
Gross Weight

91x61x49cm
Carton Dimensions

225pcs
MOQ (40HQ)

Engine Model	LC1P70FC	Cutting Width	560mm
Engine Power	3.5kW (4.8HP)	Cutting Height	25-75mm
Engine Speed	2800rpm	Height Adjustment	8-level central adjustment
Engine Displacement	196cc	Noise Level	98dB (A)
Starting System	Recoil	Blade	Straight blade
Deck Material	Steel	Wheel (inch)	Front 8, rear 10
Walk Type	Self-propelled	Grass Catcher Capacity	60L, half plastic bag
Discharge	Rear, side discharge, mulching	Features	1. Foamed upper handle 2. Front handle 3. Control panel 4. Washing hole



TB56S13A

Loncin Powered



44KG
Gross Weight

91x61x49cm
Carton Dimensions

225pcs
MOQ (40HQ)

Engine Model	V200	Cutting Width	560mm
Engine Power	4.0kW (5.4HP)	Cutting Height	25-75mm
Engine Speed	2800rpm	Height Adjustment	8-level central adjustment
Engine Displacement	196cc	Noise Level	98dB (A)
Starting System	Recoil	Blade	Straight blade
Deck Material	Steel	Wheel (inch)	Front 8, rear 10
Walk Type	Self-propelled	Grass Catcher Capacity	60L, half plastic bag
Discharge	Rear, side discharge, mulching	Features	1. Foamed upper handle 2. Front handle 3. Control panel 4. Washing hole

22" Self-propelled Models



TB56S11E

Turbo Powered



44KG
Gross Weight



91x61x49cm
Carton Dimensions



225pcs
MOQ (40HQ)

Engine Model	TB1P65F	Cutting Width	560mm
Engine Power	2.7kW (3.6HP)	Cutting Height	25-75mm
Engine Speed	2800rpm	Height Adjustment	8-level central adjustment
Engine Displacement	139cc	Noise Level	98dB (A)
Starting System	Recoil & electric start	Blade	Straight blade
Deck Material	Steel	Wheel (inch)	Front 8, rear 10
Walk Type	Self-propelled	Grass Catcher Capacity	60L, half plastic bag
Discharge	Rear, side discharge, mulching	Features	1. Foamed upper handle 2. Front handle 3. Control panel 4. Washing hole



TB56S11BE

Turbo Powered



44KG
Gross Weight



91x61x49cm
Carton Dimensions



225pcs
MOQ (40HQ)

Engine Model	TB1P70FB	Cutting Width	560mm
Engine Power	4.0kW (5.4HP)	Cutting Height	25-75mm
Engine Speed	2800rpm	Height Adjustment	8-level central adjustment
Engine Displacement	196cc	Noise Level	98dB (A)
Starting System	Recoil & electric start	Blade	Straight blade
Deck Material	Steel	Wheel (inch)	Front 8, rear 10
Walk Type	Self-propelled	Grass Catcher Capacity	60L, half plastic bag
Discharge	Rear, side discharge, mulching	Features	1. Foamed upper handle 2. Front handle 3. Control panel 4. Washing hole



TB56S13E

Loncin Powered



44KG
Gross Weight



91x61x49cm
Carton Dimensions



225pcs
MOQ (40HQ)

Engine Model	LC1P70FC	Cutting Width	560mm
Engine Power	3.5kW (4.8HP)	Cutting Height	25-75mm
Engine Speed	2800rpm	Height Adjustment	8-level central adjustment
Engine Displacement	196cc	Noise Level	98dB (A)
Starting System	Recoil & electric start	Blade	Straight blade
Deck Material	Steel	Wheel (inch)	Front 8, rear 10
Walk Type	Self-propelled	Grass Catcher Capacity	60L, half plastic bag
Discharge	Rear, side discharge, mulching	Features	1. Foamed upper handle 2. Front handle 3. Control panel 4. Washing hole



TB56S13AE

Loncin Powered



44KG
Gross Weight



91x61x49cm
Carton Dimensions



225pcs
MOQ (40HQ)

Engine Model	V200	Cutting Width	560mm
Engine Power	4.0kW (5.4HP)	Cutting Height	25-75mm
Engine Speed	2800rpm	Height Adjustment	8-level central adjustment
Engine Displacement	196cc	Noise Level	98dB (A)
Starting System	Recoil & electric start	Blade	Straight blade
Deck Material	Steel	Wheel (inch)	Front 8, rear 10
Walk Type	Self-propelled	Grass Catcher Capacity	60L, half plastic bag
Discharge	Rear, side discharge, mulching	Features	1. Foamed upper handle 2. Front handle 3. Control panel 4. Washing hole





22" Speed Adjustable Models



Speed Adjustable

TB56S11

Turbo Powered



 **44KG**
Gross Weight

 **91x61x49cm**
Carton Dimensions

 **225pcs**
MOQ (40HQ)

Engine Model	TB1P70FA	Cutting Width	560mm
Engine Power	3.6kW (4.8HP)	Cutting Height	25-75mm
Engine Speed	2800rpm	Height Adjustment	8-level central adjustment
Engine Displacement	173cc	Noise Level	98dB (A)
Starting System	Recoil	Blade	Straight blade
Deck Material	Steel	Wheel (inch)	Front 8, rear 10
Walk Type	Self-propelled	Grass Catcher Capacity	60L, half plastic bag
Discharge	Rear, side discharge, mulching	Features	1. Foamed upper handle 2. Front handle 3. Control panel 4. Washing hole



Speed Adjustable

TB56S11A

Turbo Powered



 **44KG**
Gross Weight

 **91x61x49cm**
Carton Dimensions

 **225pcs**
MOQ (40HQ)

Engine Model	TB1P70FB	Cutting Width	560mm
Engine Power	4.0kW (5.4HP)	Cutting Height	25-75mm
Engine Speed	2800rpm	Height Adjustment	8-level central adjustment
Engine Displacement	196cc	Noise Level	98dB (A)
Starting System	Recoil	Blade	Straight blade
Deck Material	Steel	Wheel (inch)	Front 8, rear 10
Walk Type	Self-propelled	Grass Catcher Capacity	60L, half plastic bag
Discharge	Rear, side discharge, mulching	Features	1. Foamed upper handle 2. Front handle 3. Control panel 4. Washing hole



Speed Adjustable

TB56S13

Loncin Powered



 **44KG**
Gross Weight

 **91x61x49cm**
Carton Dimensions

 **225pcs**
MOQ (40HQ)

Engine Model	LC1P70FC	Cutting Width	560mm
Engine Power	3.5kW (4.8HP)	Cutting Height	25-75mm
Engine Speed	2800rpm	Height Adjustment	8-level central adjustment
Engine Displacement	196cc	Noise Level	98dB (A)
Starting System	Recoil	Blade	Straight blade
Deck Material	Steel	Wheel (inch)	Front 8, rear 10
Walk Type	Self-propelled	Grass Catcher Capacity	60L, half plastic bag
Discharge	Rear, side discharge, mulching	Features	1. Foamed upper handle 2. Front handle 3. Control panel 4. Washing hole



Speed Adjustable

TB56S13A

Loncin Powered



 **44KG**
Gross Weight

 **91x61x49cm**
Carton Dimensions

 **225pcs**
MOQ (40HQ)

Engine Model	V200	Cutting Width	560mm
Engine Power	4.0kW (5.4HP)	Cutting Height	25-75mm
Engine Speed	2800rpm	Height Adjustment	8-level central adjustment
Engine Displacement	196cc	Noise Level	98dB (A)
Starting System	Recoil	Blade	Straight blade
Deck Material	Steel	Wheel (inch)	Front 8, rear 10
Walk Type	Self-propelled	Grass Catcher Capacity	60L, half plastic bag
Discharge	Rear, side discharge, mulching	Features	1. Foamed upper handle 2. Front handle 3. Control panel 4. Washing hole

22" Speed Adjustable Models



TB56S11E

Turbo Powered



44KG
Gross Weight



91x61x49cm
Carton Dimensions



225pcs
MOQ (40HQ)

Engine Model	TB1P65F	Cutting Width	560mm
Engine Power	2.7kW (3.6HP)	Cutting Height	25-75mm
Engine Speed	2800rpm	Height Adjustment	8-level central adjustment
Engine Displacement	139cc	Noise Level	98dB (A)
Starting System	Recoil & electric start	Blade	Straight blade
Deck Material	Steel	Wheel (inch)	Front 8, rear 10
Walk Type	Self-propelled	Grass Catcher Capacity	60L, half plastic bag
Discharge	Rear, side discharge, mulching	Features	1. Foamed upper handle 2. Front handle 3. Control panel 4. Washing hole



Speed Adjustable



TB56S11BE

Turbo Powered



44KG
Gross Weight



91x61x49cm
Carton Dimensions



225pcs
MOQ (40HQ)

Engine Model	TB1P70FB	Cutting Width	560mm
Engine Power	4.0kW (5.4HP)	Cutting Height	25-75mm
Engine Speed	2800rpm	Height Adjustment	8-level central adjustment
Engine Displacement	196cc	Noise Level	98dB (A)
Starting System	Recoil & electric start	Blade	Straight blade
Deck Material	Steel	Wheel (inch)	Front 8, rear 10
Walk Type	Self-propelled	Grass Catcher Capacity	60L, half plastic bag
Discharge	Rear, side discharge, mulching	Features	1. Foamed upper handle 2. Front handle 3. Control panel 4. Washing hole



Speed Adjustable



TB56S13E

Loncin Powered



44KG
Gross Weight



91x61x49cm
Carton Dimensions



225pcs
MOQ (40HQ)

Engine Model	LC1P70FC	Cutting Width	560mm
Engine Power	3.5kW (4.8HP)	Cutting Height	25-75mm
Engine Speed	2800rpm	Height Adjustment	8-level central adjustment
Engine Displacement	196cc	Noise Level	98dB (A)
Starting System	Recoil & electric start	Blade	Straight blade
Deck Material	Steel	Wheel (inch)	Front 8, rear 10
Walk Type	Self-propelled	Grass Catcher Capacity	60L, half plastic bag
Discharge	Rear, side discharge, mulching	Features	1. Foamed upper handle 2. Front handle 3. Control panel 4. Washing hole



Speed Adjustable



TB56S13AE

Loncin Powered



44KG
Gross Weight



91x61x49cm
Carton Dimensions



225pcs
MOQ (40HQ)

Engine Model	V200	Cutting Width	560mm
Engine Power	4.0kW (5.4HP)	Cutting Height	25-75mm
Engine Speed	2800rpm	Height Adjustment	8-level central adjustment
Engine Displacement	196cc	Noise Level	98dB (A)
Starting System	Recoil & electric start	Blade	Straight blade
Deck Material	Steel	Wheel (inch)	Front 8, rear 10
Walk Type	Self-propelled	Grass Catcher Capacity	60L, half plastic bag
Discharge	Rear, side discharge, mulching	Features	1. Foamed upper handle 2. Front handle 3. Control panel 4. Washing hole



Speed Adjustable





Side Discharge Mowers



Lightweight Design



Fuel Efficient



Easy Controls



Compact Storage

OPTIONAL COVERS



Foamed Handlebar
Comfortable operation

Quick Locks

Compact & Lightweight
Easy maneuverability with high efficiency cutting

5 Adjustable Cutting Heights
25-75mm central adjustment

Extra-Large Chute
Upgraded durability & enhanced discharge efficiency

Multiple Engine Options
Turbo cover options & brand options

Sturdy Steel Deck
Upgraded material for enhanced durability

17/20 inch (450/500mm) Cutting Width Options

Extra-Large 12" (300mm) Rear Wheels



Extra-Large Discharge Chute

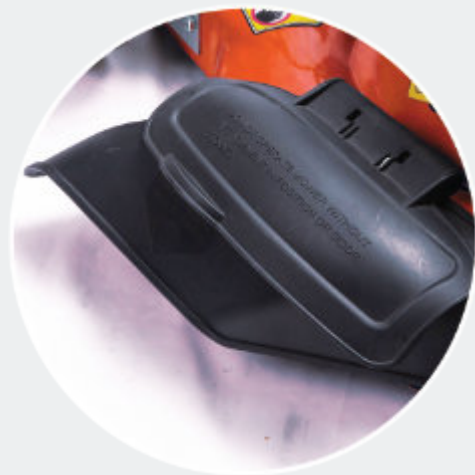

 **All models are customizable.**

 **E-start available.**



Side-Discharge Models



TB45P01

Turbo Powered



29KG
Gross Weight

71x56x38cm
Carton Dimensions

469pcs
MOQ (40HQ)

Engine Model	TB1P65F	Discharge	Side discharge
Engine Power	2.7kW (3.7HP)	Cutting Width	450mm
Engine Speed	2800rpm	Cutting Height	25-75mm
Engine Displacement	139cc	Height Adjustment	5-level central adjustment
Starting System	Recoil	Noise Level	96dB (A)
Deck Material	Steel	Blade	Straight blade
Walk Type	Hand push	Wheel (inch)	Front 7, rear 7



TB45P02

B&S Powered



29KG
Gross Weight

71x56x38cm
Carton Dimensions

469pcs
MOQ (40HQ)

Engine Model	BS500E	Discharge	Side discharge
Engine Power	2.1kW (2.8HP)	Cutting Width	450mm
Engine Speed	2800rpm	Cutting Height	25-75mm
Engine Displacement	140cc	Height Adjustment	5-level central adjustment
Starting System	Recoil	Noise Level	96dB (A)
Deck Material	Steel	Blade	Straight blade
Walk Type	Hand push	Wheel (inch)	Front 7, rear 7



TB45P03

Loncin Powered



29KG
Gross Weight

71x56x38cm
Carton Dimensions

469pcs
MOQ (40HQ)

Engine Model	LC1P65FE	Discharge	Side discharge
Engine Power	2.4kW (3.2HP)	Cutting Width	450mm
Engine Speed	2800rpm	Cutting Height	25-75mm
Engine Displacement	139cc	Height Adjustment	5-level central adjustment
Starting System	Recoil	Noise Level	96dB (A)
Deck Material	Steel	Blade	Straight blade
Walk Type	Hand push	Wheel (inch)	Front 7, rear 7



TB45P04C

RATO Powered



29KG
Gross Weight

71x56x38cm
Carton Dimensions

469pcs
MOQ (40HQ)

Engine Model	RV145-S	Discharge	Side discharge
Engine Power	2.5kW (3.4HP)	Cutting Width	450mm
Engine Speed	2800rpm	Cutting Height	25-75mm
Engine Displacement	144cc	Height Adjustment	5-level central adjustment
Starting System	Recoil	Noise Level	96dB (A)
Deck Material	Steel	Blade	Straight blade
Walk Type	Hand push	Wheel (inch)	Front 7, rear 7



TB50P01

Turbo Powered



31KG
Gross Weight



84x56x42cm
Carton Dimensions



336pcs
MOQ (40HQ)

Engine Model	TB1P70FA	Discharge	Side discharge
Engine Power	3.6kW (4.8HP)	Cutting Width	500mm
Engine Speed	2800rpm	Cutting Height	25-75mm
Engine Displacement	173cc	Height Adjustment	5-level central adjustment
Starting System	Recoil	Noise Level	98dB (A)
Deck Material	Steel	Blade	Straight blade
Walk Type	Hand push	Wheel (inch)	Front 8, rear 12



TB50P02

B&S Powered



31KG
Gross Weight



84x56x42cm
Carton Dimensions



336pcs
MOQ (40HQ)

Engine Model	BS500E	Discharge	Side discharge
Engine Power	2.1kW (2.8HP)	Cutting Width	500mm
Engine Speed	2800rpm	Cutting Height	25-75mm
Engine Displacement	140cc	Height Adjustment	5-level central adjustment
Starting System	Recoil	Noise Level	98dB (A)
Deck Material	Steel	Blade	Straight blade
Walk Type	Hand push	Wheel (inch)	Front 8, rear 12



TB50P03

Loncin Powered



31KG
Gross Weight



84x56x42cm
Carton Dimensions



336pcs
MOQ (40HQ)

Engine Model	LC1P65FC	Discharge	Side discharge
Engine Power	2.7kW (3.6HP)	Cutting Width	500mm
Engine Speed	2800rpm	Cutting Height	25-75mm
Engine Displacement	159cc	Height Adjustment	5-level central adjustment
Starting System	Recoil	Noise Level	98dB (A)
Deck Material	Steel	Blade	Straight blade
Walk Type	Hand push	Wheel (inch)	Front 8, rear 12



TB50P04

RATO Powered



31KG
Gross Weight



84x56x42cm
Carton Dimensions



336pcs
MOQ (40HQ)

Engine Model	RV170-S	Discharge	Side discharge
Engine Power	2.8kW (3.8HP)	Cutting Width	500mm
Engine Speed	2800rpm	Cutting Height	25-75mm
Engine Displacement	170cc	Height Adjustment	5-level central adjustment
Starting System	Recoil	Noise Level	98dB (A)
Deck Material	Steel	Blade	Straight blade
Walk Type	Hand push	Wheel (inch)	Front 8, rear 12



Zero-Turn Gasoline Mower



Free Steering



Intuitive Control



Easy Switch



Unique Design

OPTIONAL COVERS

Foamed Handlebar

Comfortable operation

Self Propelled



One-Button E-Start

New Panel Design

Built-in Cup Holder

Quick Locks

65L Grass Catcher

Extended runtime

Powerful Engine

Multiple options available



Zero-Turn System

Free steering with directional lock

7 Adjustable Cutting Heights

25-75mm central adjustment

Sturdy Steel Deck

Upgraded material for enhanced durability



A



B



C



D



E

Zero-Turn System Available for 20, 21 & 22-inch Models

ZERO-TURN

Turbo Powered

TURBO



50KG

Gross Weight



86x57x49cm

Carton Dimensions



270pcs

MOQ (40HQ)

Engine Model	TB1P70FA	Cutting Width	510mm
Engine Power	3.6kW (4.8HP)	Cutting Height	25-75mm
Engine Speed	2800rpm	Height Adjustment	7 (center height adjustment)
Engine Displacement	173cc	Noise Level	98dB (A)
Starting System	Recoil	Blade	Straight blade
Deck Material	Steel	Wheel (inch)	Front 8,Rear 10
Walk Type	Self-propelled	Grass Catcher Capacity	65L, half plastic grass bag
Discharge	Rear, side discharge, mulching	Features	<ol style="list-style-type: none"> 1. Two ZERO-TURN swivel wheels 2. Interlocked central height adjustment 3. Grass comb 4. Upgraded chassis



ALWAYS LEVELLED CENTRAL HEIGHT ADJUSTMENT

One-handed Central Height Adjustment



Fully Protected Engine & Belt with Bottom Cover



One-handed Directional Lock



Curled Rim for Enhanced Chassis Durability



Foldable Mower



Space Saving



Quick Lock



Tool-Free Folding



Durable & Robust

Ready to Mow in 60 Seconds

*Available for 18", 20" and 21" Models.

1 Unpack



2 Unfold



3 Ready to Mow



Quick Locks

Adjustable Handle Height



Foldable: Saves up to 50% of Storage Space





Cross-Blade System



Powerful



Robust Build



Upgraded Material



Efficiency Increase

PATENTED CROSS-BLADE & FAN SYSTEM

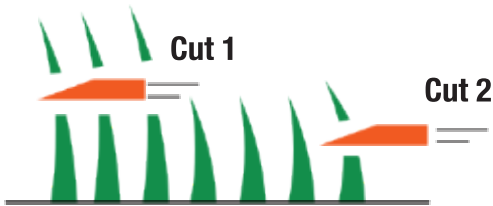

✓ **Double Cutting**

✓ **60% INCREASE**
in discharge efficiency

✓ **Grass Compression**
for more storage

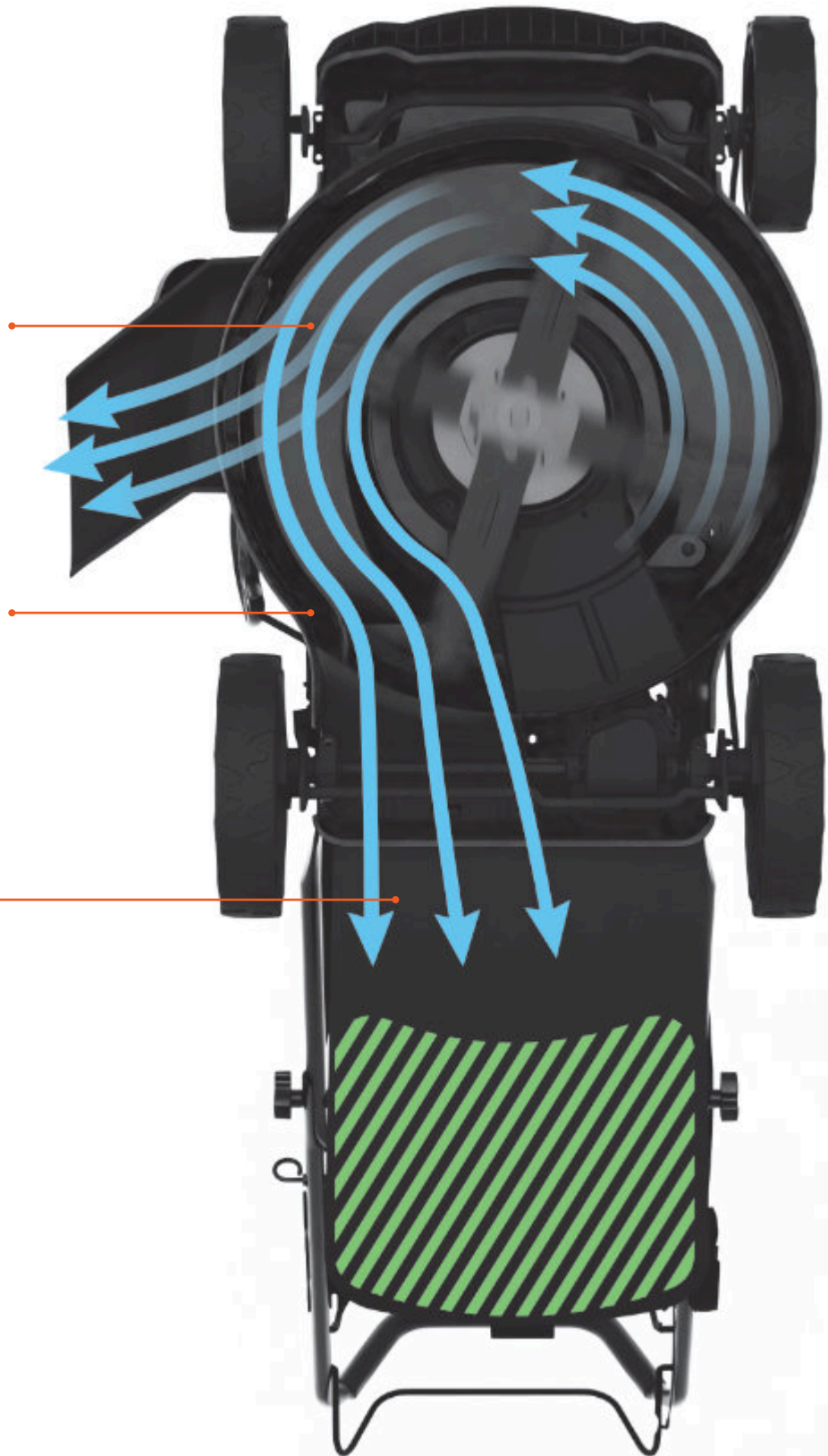

PATENTED CROSS-BLADE & FAN SYSTEM

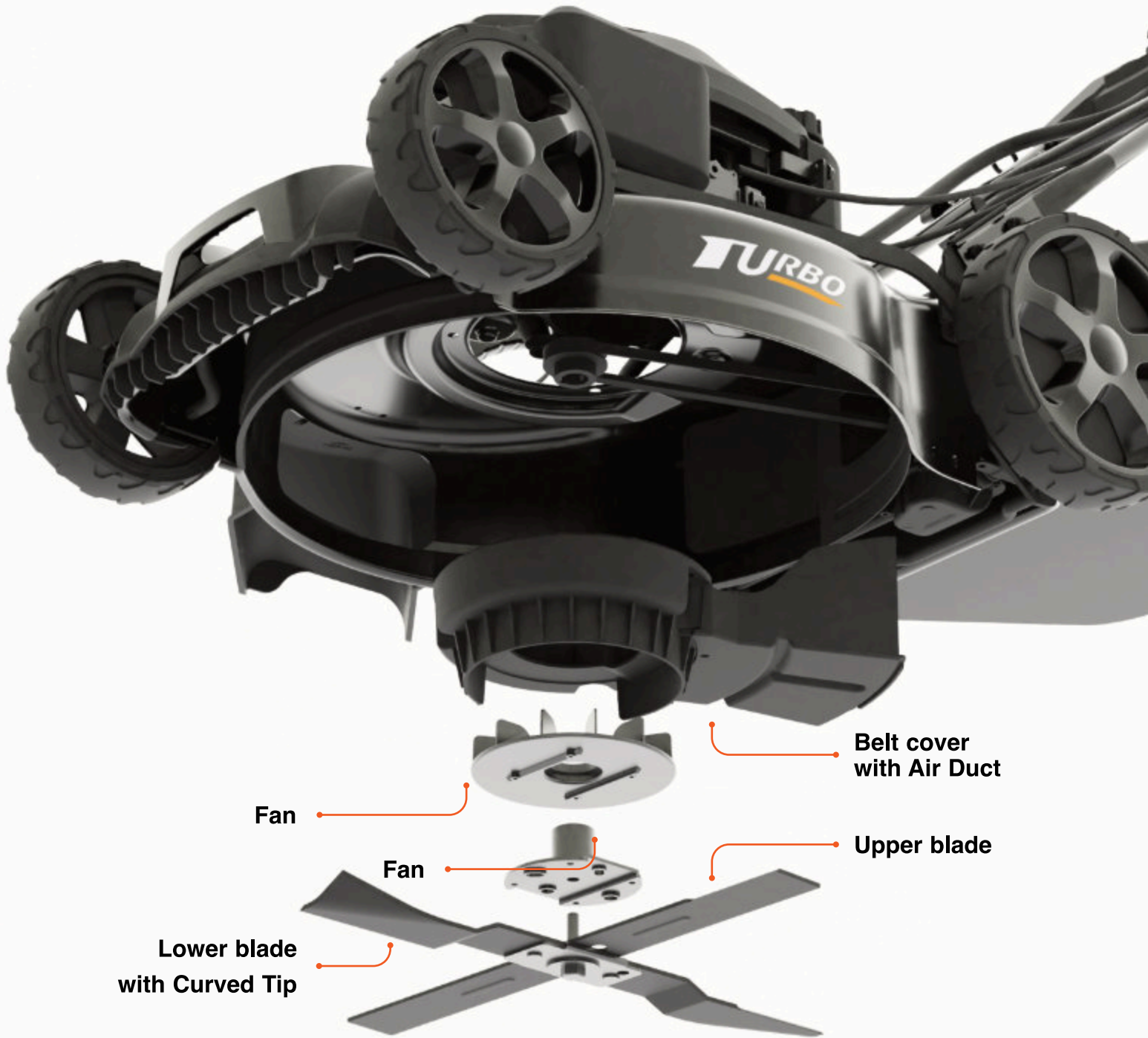

Turbo Vertical Shaft Engines



Customizable



Multiple Options



Powerful



Reliable



Each Unit Tested



Certified

Turbo Vertical-Shaft Engines

Suitable for lawn mowers, tillers & trimmers



One-Pull Start



5 Patented Covers



Low Maintenance



EURO V Certified



All Spare Parts Available

Cover A



Cover B



Cover C



Cover D



Cover E



Turbo Engine Specifications

**11-13kg
Heavy Duty**

**Robust
& Durable**

**E-Start
Available**



MODEL NO. TB1P65F

TB1P70FA

TB1P70F

Displacement	139 cc	173 cc	196 cc
Positioning	Compact & Cost-Efficient	Balanced Performance	High Torque Performance
Engine Type	Single-cylinder, air-cooled, 4-stroke OHV	Single-cylinder, air-cooled, 4-stroke OHV	Single-cylinder, air-cooled, 4-stroke OHV
Bore × Stroke (mm)	65 × 42	70 × 45	70 × 51
Max Torque (Nm/rpm)	8.5 / 2600	9.5 / 2600	12.0 / 2500
Max Power (kW/rpm)	2.7 / 3600	3.3 / 3600	3.6 / 3600
Max Power (hp/rpm)	3.7HP	4.9HP	5.5HP
Starting System	Recoil / E-start	Recoil / E-start	Recoil / E-start
Fuel Tank (L)	1.5	1.5	1.5
Oil Capacity (L)	0.6	0.6	0.6
Net Weight (kg)	11	12.8	13
Dimensions (mm)	415 × 335 × 355	420 × 335 × 365	425 × 335 × 365

Collaborating Engine Brands



LC1P65FE - 123cc



LC1P65FE-C - 139cc



LC1P65FE-2 - 166cc



V200 - 196cc



LC1P70FC - 196cc



GCV145 - 145cc



GCV170 - 170cc



GCV200 - 200cc



450E - 125cc



500E - 140cc



550E - 140cc



750EX DOV- 161cc



Electric Corded Mowers



Long Runtime



Classic Design



Eco-Friendly



Budget Models

Upgraded Electric Motor

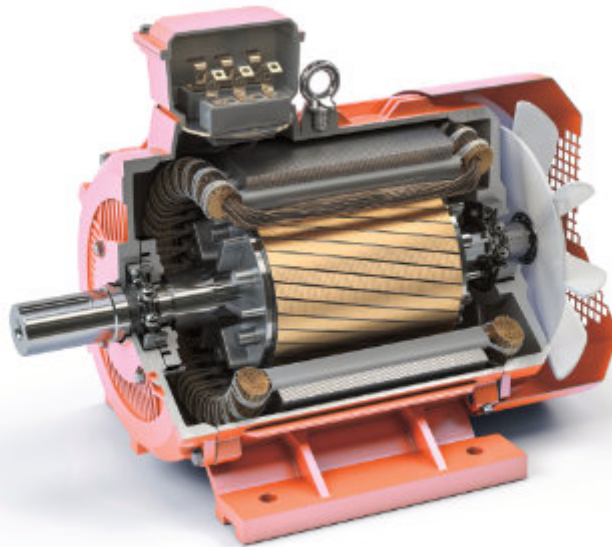

No More Overheat

- Smart temperature sensors
- Auto overload protection
- Durable carbon brushes
- Strong & durable belt
- Smooth & stable output
- Longer life & safer use



Premium Carbon Brush



Enhanced Belt





TBE1332

1300W

Voltage:	230V-240V~, 50Hz
Wattage:	1300W
Speed (no load):	3300r/min
Cutting width:	320mm
Height adjustment:	3 (30-60mm approx.)
Advised max. cutting area:	400m ² approx.
Grass collection box capacity:	30L (full plastic)
Wheels Diameter:	Φ125mm/Φ140mm

 **12KG**
Gross Weight

 **62x39x32cm**
Carton Dimensions

 **929pcs**
MOQ (40HQ)



TBE1636

1600W

Voltage:	230V-240V~, 50Hz
Wattage:	1600W
Speed (no load):	3600r/min
Cutting width:	360mm
Height adjustment:	6 (20-70mm approx.)
Advised max. cutting area:	500m ² approx.
Grass collection box capacity:	40L (full plastic)
Wheels Diameter:	Φ140mm/Φ198mm

 **15KG**
Gross Weight

 **69x45x37cm**
Carton Dimensions

 **616pcs**
MOQ (40HQ)





TBE1842

1800W

Voltage:	230V-240V~, 50Hz
Wattage:	1800W
Speed (no load):	3600r/min
Cutting width:	420mm
Height adjustment:	6 (20-70mm approx.)
Advised max. cutting area:	700m ² approx.
Grass collection box capacity:	40L (full plastic)
Wheels Diameter:	Φ160mm/Φ215mm

 **16KG**
Gross Weight

 **70x47x37cm**
Carton Dimensions

 **595pcs**
MOQ (40HQ)



Open for Partnership

TBE1330

1300W

Voltage:	230~ 50Hz
Wattage:	1000/1100W
Wheel Diameter:	Front 12.5cm, Rear 12.5cm
Speed:	3800/min
Cutting Width:	320 mm
Cutting height:	30~60mm, 3-level
Grass box Capacity:	38L Plastic Bag
Advised max. cutting area:	400m ² approx.



12KG
Gross Weight



62x39x32cm
Carton Dimensions



929pcs
MOQ (40HQ)



TBE1640

1600W

Voltage:	230~ 50Hz
Wattage:	1600/1700W
Wheel Diameter:	Front 17cm, Rear 22cm
Speed:	3800/min
Cutting Width:	400 mm
Cutting height:	20~70mm,6
Grass box Capacity:	45L Plastic Top + Fabric Bag
Advised max. cutting area:	500m ² approx.



15KG
Gross Weight



67x45x37cm
Carton Dimensions



616pcs
MOQ (40HQ)



TBE1844

1800W

Voltage:	230~ 50Hz
Wattage:	1800/1900W
Wheel Diameter:	Front 17cm, Rear 22cm
Speed:	3800/min
Cutting Width:	440mm
Cutting height:	20~70mm, 6 levels
Grass box Capacity:	45L Plastic Top + Fabric Bag
Advised max. cutting area:	700m ² approx.



19KG
Gross Weight



70x47x37cm
Carton Dimensions



595pcs
MOQ (40HQ)



Open for Partnership

Multi-Sensor System

Patented GPS Algorithm

Built-in Handle

Swappable Workload

All Terrain Track



"JUPITER" Robotic Lawn Mower

Prototype Field-Tested in
Poland, Germany, Belgium & Spain





Self Propelled Trimmer



Powerful Drive



Effortless Operation



Smooth & Stable



High-Torque Trimming

OPTIONAL COVERS



Foamed Handlebar
Comfortable operation

Self Propelled

Throttle Control
Handy & precise walk speed adjustment

One-Pull Recoil Start
Reliable experience

Foldable Handle Bar
Unbox & ready to use

Sturdy Build
Dual-lock handle bar reinforcement

Powerful Engine
Multiple options available

Steel Deck with Handle Bar
Sturdy, efficient & easy to move around

Large 10" Wheels
Easy maneuverability

Sturdy Bumper with Built-in Bar
Tough, rigid bumper for a secured operation

22-inch (560mm) Cutting Width

Self-Propelled Walk-Behind Trimmer

Turbo Powered	TURBO	26KG Gross Weight	77×49×53cm Carton Dimensions	360pcs MOQ (40HQ)
Engine	OHV, 4-stroke, air-cooled	Walk-Type	Self-propelled	
Engine Model	TB1P70FA	Wheels	10"	
Displacement	173cc	Starting System	Recoil	
Deck	Metal Deck	Cutting Width	22" (560mm)	
String Diameter	4.0mm	Cutting Height	35mm~75mm	

***Hand-pushed model coming soon.**

Fully Protected Bottom for Better Durability

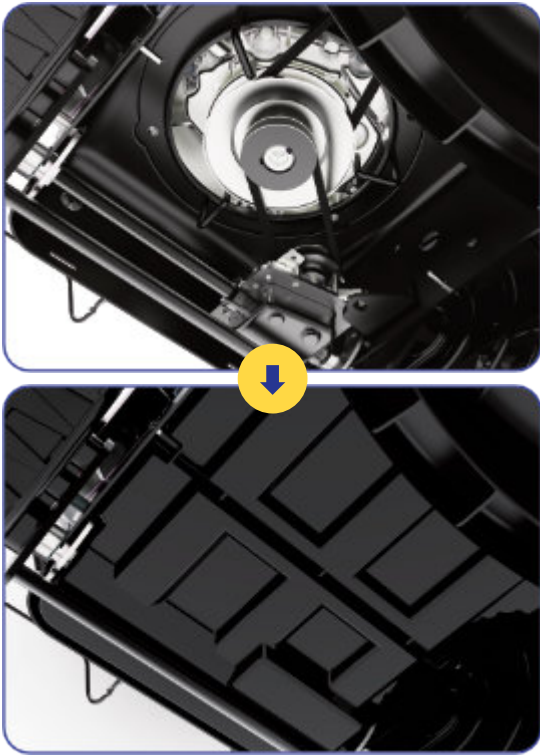

Tougher Build with Rigid Bumper



Trimming Height Adjustable

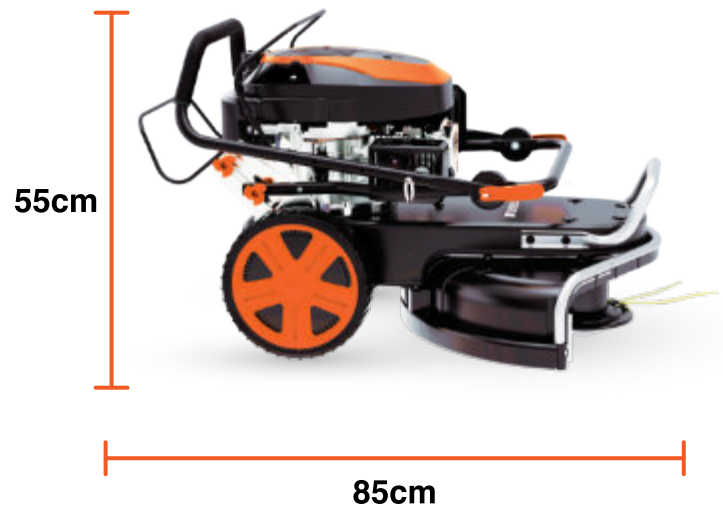

Foldable Design Saves up to 50% of Storage Space

Front Tine Tillers



Powerful Tilling



Adjustable Width



Easy Controls



Durable Tines



OPTIONAL COVERS



One-Button E-Start



Copper Gears



Each Blade is Swappable



**Compact Packaging
430pcs in 40HQ**





Front-Tine Tillers



TB36T1

4-Bladed



36KG
Gross Weight



66x38x65cm
Carton Dimensions



430pcs
MOQ (40HQ)

Engine Model	TB1P65F	Tilling Width	360mm
Engine Power	2.7kW (3.6HP)	Max. Tilling Depth	270mm
Engine Speed	3000rpm	No. of Blade Groups	4
Engine Displacement	139cc	Wheels	6" (front)
Starting System	Recoil	Features	Swappable Blades



TB60T1

6-Bladed



39KG
Gross Weight



66x38x65cm
Carton Dimensions



430pcs
MOQ (40HQ)

Engine Model	TB1P65F	Tilling Width	600mm
Engine Power	2.7kW (3.6HP)	Max. Tilling Depth	270mm
Engine Speed	3000rpm	No. of Blade Groups	6
Engine Displacement	139cc	Wheels	6" (front)
Starting System	Recoil	Features	Swappable, protected blades



TB60T1B

6-Bladed



40KG
Gross Weight



66x38x65cm
Carton Dimensions



430pcs
MOQ (40HQ)

Engine Model	TB1P70FA	Tilling Width	600mm
Engine Power	3.6kW (4.8HP)	Max. Tilling Depth	270mm
Engine Speed	3000rpm	No. of Blade Groups	6
Engine Displacement	173cc	Wheels	6" (front)
Starting System	Recoil	Features	Swappable, protected blades



Front-Tine Tillers



TB36T3A

4-Bladed



36KG
Gross Weight



66x38x65cm
Carton Dimensions



430pcs
MOQ (40HQ)

Engine Model	LC1P65FE	Tilling Width	600mm
Engine Power	2.4kW (3.2HP)	Max. Tilling Depth	270mm
Engine Speed	3000rpm	No. of Blade Groups	6
Engine Displacement	159cc	Wheels	6" (front)
Starting System	Recoil	Features	Swappable, protected blades

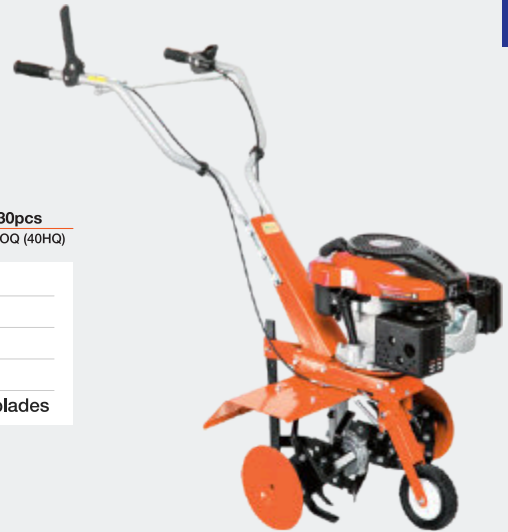

TB60T3

6-Bladed



36KG
Gross Weight



66x38x65cm
Carton Dimensions



430pcs
MOQ (40HQ)

Engine Model	LC1P65FE	Tilling Width	600mm
Engine Power	2.4kW (3.2HP)	Max. Tilling Depth	270mm
Engine Speed	3000rpm	No. of Blade Groups	6
Engine Displacement	139cc	Wheels	6" (front)
Starting System	Recoil	Features	Swappable, protected blades



TB60T3B

6-Bladed



36KG
Gross Weight



66x38x65cm
Carton Dimensions



430pcs
MOQ (40HQ)

Engine Model	LC1P65FC	Tilling Width	600mm
Engine Power	2.7kW (3.6HP)	Max. Tilling Depth	270mm
Engine Speed	3000rpm	No. of Blade Groups	6
Engine Displacement	159cc	Wheels	6" (front)
Starting System	Recoil	Features	Swappable, protected blades

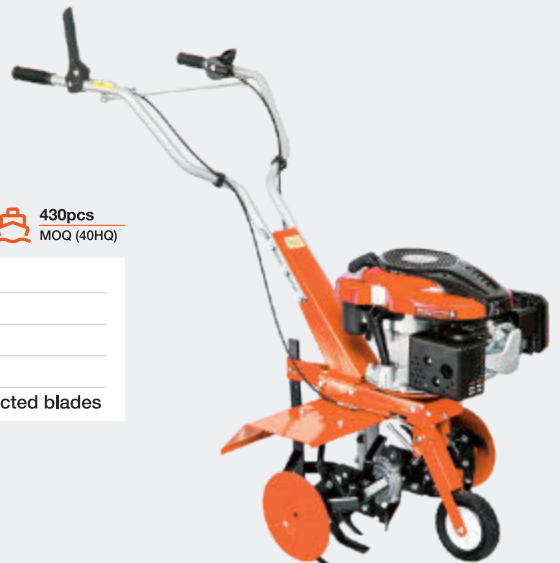



Horizontal Shaft Engines



Customizable



Multiple Options



Powerful



Reliable



Each Unit Tested



Certified



DT170F

211CC

Displacement (cc)	211
Bore x Stroke (mm)	70x55
Rated Power Output (kW/rpm)	4.3/3600
Max Torque (Nm/rpm)	10/2500
Fuel Tank Capacity (L)	3.6
Oil Capacity (L)	0.6
Starting System	Recoil
Dimensions (mm)	400x370x380
Net Weight (kg)	14



MF170FA

212CC

Displacement (cc)	212
Bore x Stroke (mm)	70 x 55
Rated Power Output (kW/rpm)	4.2 / 3600
Max Torque (Nm/rpm)	12 / 3000 ±500
Fuel Tank Capacity (L)	3.6
Oil Capacity (L)	0.6
Starting System	Recoil
Dimensions (mm)	425 x 330 x 395
Net Weight (kg)	14



MF170FA-1

223CC

Displacement (cc)	223
Bore x Stroke (mm)	70 x 58
Rated Power Output (kW/rpm)	4.5 / 3600
Max Torque (Nm/rpm)	12.5 / 3000 ±500
Fuel Tank Capacity (L)	4.0
Oil Capacity (L)	0.6
Starting System	Recoil
Dimensions (mm)	425 x 330 x 395
Net Weight (kg)	14



B&S 130G32

208CC

Displacement (cc)	208
Bore x Stroke (mm)	70 x 54
Rated Power Output (kW/rpm)	4.9 / 3600
Max Torque (Nm/rpm)	12.9 / 3000 ±500
Fuel Tank Capacity (L)	3.03
Oil Capacity (L)	0.6
Starting System	Recoil
Dimensions (mm)	287 x 366 x 378
Net Weight (kg)	16.1



Reverse Gear Tiller



Easy Direction Swap



Adjustable Width



Powerful Engine



Durable Tines

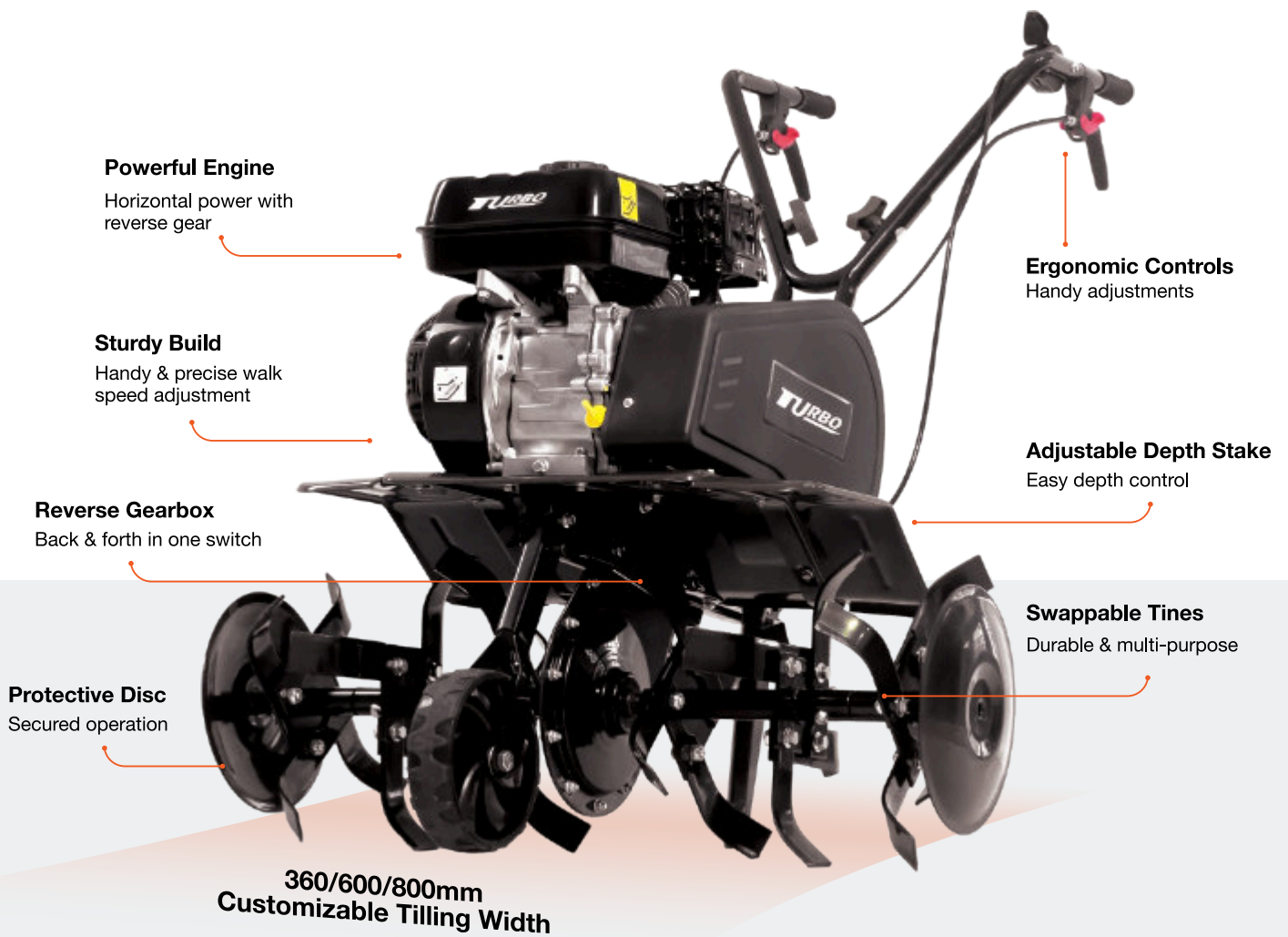

TB85TR1

Turbo Powered



50KG
Gross Weight



62x38x69cm
Carton Dimensions



399pcs
MOQ (40HQ)

Engine Model	LB170F	Tilling Width	360/600/800mm customizable
Engine Power	4.8kW (6HP)	Max. Tilling Depth	100-250mm
Engine Speed	3600rpm	No. of Blade Groups	6
Engine Displacement	212cc	Wheels	6" (front)
Starting System	Recoil	Blade Diameter	340mm
Brake System	Belt & Chain	Features	Swappable Blades

All models are customizable.



SWAPPABLE TINES



Cage Wheels



Double-Sided Plow



Single-Sided Plow



Potato Plow



Resistance Rod



Powerful Engine

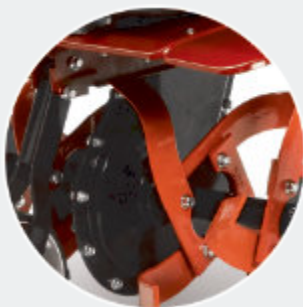

Heavy-Duty Gearbox





Rear Tine Tiller



Maximum Power



Counter-Rotating
Tines



Heavy-Duty Build



Professional Choice



Rear-Tine Tiller

Turbo Powered

TURBO



72KG
Gross Weight



112x53x49cm
Carton Dimensions



220pcs
MOQ (40HQ)

Engine Displacement	212cc	Tilling Depth	203 mm
Engine Type	4-Stroke OHV	Tilling Depth Adjustments	41 mm Increments
Fuel Capacity	3.1 L	Wheel Diameter	330 mm
Oil Capacity	500 ml	Length	149 cm
Oil Type	10W-30	Width	50 cm
Tine Diameter	350 mm	Height	126 cm
Tilling Width	483 mm		

All models are customizable.

**Ergonomic Controls
for Easy Handling
with Secure Locker**



**Large Front
Bumper-Handle
with Logo**



**33cm (13-inch)
Durable Pneumatic Wheels**



**12pc Heavy Duty
Steel Tines**





**Robust Engine
with Worm Gears &
Belt Drive System**



**Adjustable
Tiller Depth
with Protector**



Gasoline Scarifier



Dual Function



Promotes Growth



User Friendly



Low Maintenance





Scarifier

Turbo Powered	TURBO	45KG Gross Weight	74x65x53cm Carton Dimensions	270pcs MOQ (40HQ)
Engine	OHV, 4-stroke, air-cooled	Wheels	Front 8, rear 10	
Displacement	212cc	Starting system	Recoil	
Power	4.0~4.5KW	Cutting height adjustment	6 individual position	
No-load Blade speed	2500rpm	Cutting Height	-15mm/-10mm/-5mm/0mm/6mm/+12mm	
Deck	Metal	Blade	Scarifier / Ventilation	
Cutting width	16" (450mm)	Grass bag	45L	
Walk Type	Hand push			

Steel Wire Brush:

- Steel Wire Teeth No.: 26
- Steel Wire Diameter: Φ 2.2mm
- Rotation Diameter: Φ 180mm
- Cutting Width: 450mm



Rotary Blade Brush:

- Blade Teeth No.: 13
- Blade Thickness: 2mm
- Rotation Diameter: Φ 180mm
- Cutting Width: 450mm

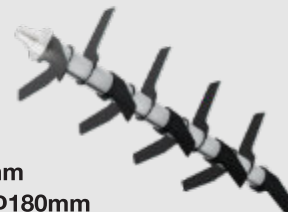

Low Oil Alert



One-Button E-Start Available

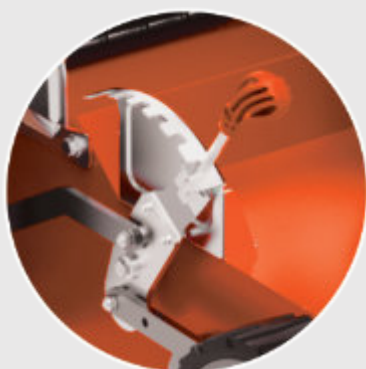
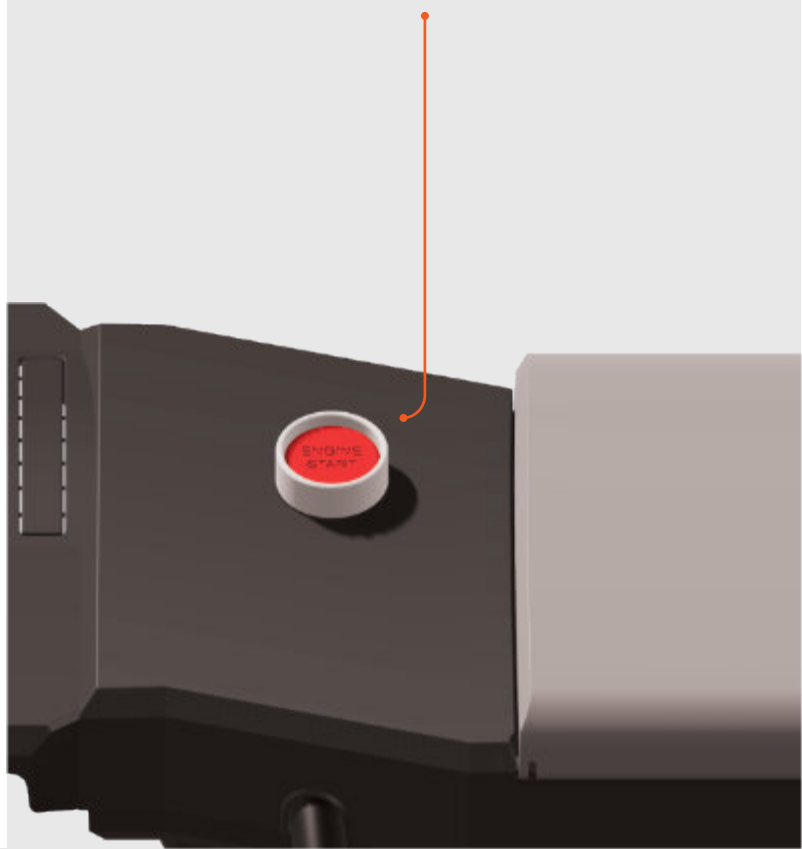

Central Height Adjustment

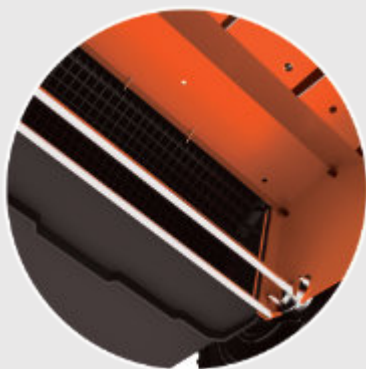

Extra Reinforcing Bar at Rear Axle

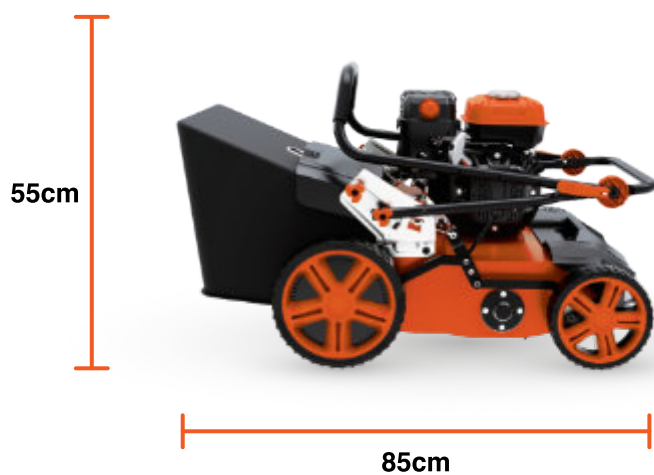

Foldable Design
Saves up to 50% of Storage Space

PARTS

Front Handles

A



B



C



D



Control Panels



Basic Panel



E-Start Panel with Battery Slot

Quick Locks

A



B



Mower Blades • All Sizes Available

- ✓ Magnesium Steel
- ✓ Long-Lasting Sharpness
- ✓ Impact Resistant
- ✓ Precision Cutting Edge



Blade Length: All sizes available

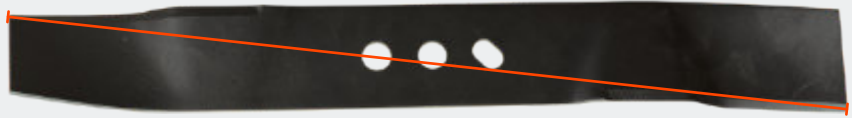

Turbo's Unique Dock



Thickness: 4mm

Available in all sizes



Compact Packaging



Optional: Swivel Blade Set

Blade Length: All sizes available



Durable Blade Disc

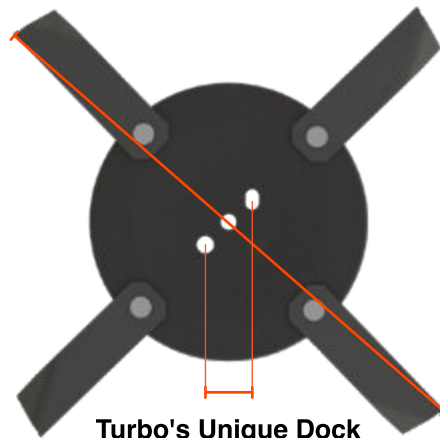

Turbo's Unique Dock

Spare Parts



Transmission



Carburetors



Spark Plugs

Battery Packs



Built-in Indicator

Basic Charger



Premium Charger



Belts



Starter Coils

Optional Wheel Cover A



Optional Wheel Cover B



Optional Wheel Cover C



Accessories



Protective Goggles



Hearing Protection



Protective Gloves



Thank you for taking the time to explore our products.



We respond quickly.

We understand your requirements.

We deliver according to agreed time.

We ensure consistent quality and supports.

And we always keep our promises.



**— Dan Li
General Manager**



TURBO
GARDENING MACHINERY



ZHEJIANG TURBO GARDENING MACHINERY CO., LTD.

✉ dan.li@turbogardening.com

★ www.turbogardening.com

📍 #138 East Jianghuan Rd., The East Industrial Park,
Shangyu, Zhejiang, China, 312300

☎ +86 187 2109 6950

SCAN FOR WECHAT



www.turbogardening.com